

## AUSTRIA | MOLTO LUCE GMBH

HEADQUARTERS WELS  
Office & Showroom  
Europastraße 45  
4600 Wels  
T: +43 7242 698-0  
M: office@moltoluce.com

VIENNA  
Office & Showroom  
Vorarlberger Allee 28  
1230 Vienna  
T: +43 1 6160300  
M: office.wien@moltoluce.com

GRAZ  
Office  
Robert-Viertl-Straße 2  
8055 Graz  
T: +43 316 672525-0  
M: office.graz@moltoluce.com

INNSBRUCK  
Office  
Orbis Office, Resselstraße 33 / Top 5  
6020 Innsbruck  
T: +43 512 345688  
M: office.innsbruck@moltoluce.com

## GERMANY | MOLTO LUCE GMBH

MUNICH  
Office & Showroom  
Walter-Gropius-Straße 23  
80807 Munich  
T: +49 89 4520565-0  
M: office.muenchen@moltoluce.com

COLOGNE  
Office & Showroom  
Gut Maarhausen, Eiler Straße 3v  
51107 Cologne  
T: +49 221 222882-0  
M: office.koeln@moltoluce.com

HAMBURG  
Office & Showroom  
Wandsbeker Allee 77  
22041 Hamburg  
T: +49 40 2847850-1  
M: office.hamburg@moltoluce.com

## ITALY | MOLTO LUCE srl

BRESCIA  
Office  
Viale Duca D' Aosta 28  
25121 Brescia  
T: +39 030 2400679  
M: office.brescia@moltoluce.com

## SWITZERLAND | MOLTO LUCE AG

LENZBURG  
Office  
Niederlenzerstraße 25  
5600 Lenzburg  
T: +41 62 885 70 30  
M: office.lenzburg@moltoluce.com

[www.moltoluce.com](http://www.moltoluce.com)

MOLTO LUCE®



















V\_0\_002





















TRAIL

MOLTO LUCE®

## INHALT / CONTENT

|   |   |  |  |   |  |   |  |
|---|---|--|--|---|--|---|--|
| <br>MOUNTING RAIL<br>10     | <br>FEED IN<br>11            | <br>CONNECTORS<br>12          | <br>EMPTY RAIL<br>13      | <br>COVERS<br>13           | <br>FIXING COMPONENTS<br>14 / 15 | <br>ACCESSORIES<br>15          | <br>LIGHT INSERT LINEAR<br>17 / 18 / 19 |
| <br>LIGHT INSERT MOVA<br>22 | <br>LIGHT INSERT ARTIS<br>23 | <br>SAFETY LIGHT INSERT<br>24 | <br>HIGH-BAY INSERT<br>26 | <br>UNIVERSAL INSERT<br>27 | <br>SENSOR INSERT<br>28          | <br>MOTION DETEC. INSERT<br>29 | <br>TRAIL INFO<br>30 - 43               |

## LEGENDE / LEGEND

|   | OBERFLÄCHENFARBEN    | SURFACE COLOURS       |
|---|----------------------|-----------------------|
|    | silber               | silver                |
|    | weiß                 | white                 |
|    | schwarz              | black                 |
|   | LED INFORMATION      | LED INFORMATION       |
|  | LED 3000K            | LED 3000K             |
|  | LED 3500K            | LED 3500K             |
|  | LED 4000K            | LED 4000K             |
|  | LED 6500K            | LED 6500K             |
|   | ABSTRAHLUNG          | BEAM ANGLE            |
|  | ASYMMETRISCH         | ASYMMETRIC            |
|  | DOPPELASYMMETRISCH   | DOUBLE ASYMMETRIC     |
|  | BREITSTRAHLEND 90°   | WIDE BEAM 90°         |
|  | MEDIUMSTRAHLEND 60°  | MEDIUM BEAM 60°       |
|  | TIEFSTRAHLEND 30°    | NARROW BEAM 30°       |
|  | REFLEKTOR SPOT       | REFLECTOR SPOT        |
|  | REFLEKTOR MEDIUM     | REFLECTOR MEDIUM      |
|  | REFLEKTOR FLOOD      | REFLECTOR FLOOD       |
|  | REFLEKTOR WIDE FLOOD | REFLECTOR WIDE FLOOD  |
|   | TECHNISCHE INFO      | TECHNICAL INFO        |
|  | SYSTEMLEISTUNG       | SYSTEM POWER          |
|  | DREH- UND SCHWENKBAR | SWIVELING AND TILTING |
|  | SCHALTBAR            | SWITCHABLE            |
|  | DALI DIMMBAR         | DALI DIMMABLE         |
|  | DALI 2 DIMMBAR       | DALI 2 DIMMABLE       |



### INDIVIDUELL KONFIGURIERBAR

Das gesamte System kann an spezielle Anforderungen und Bedürfnisse angepasst werden.  
Mehr Infos auf Seite 25

### INDIVIDUALLY CONFIGURABLE

The entire Trail system can be adapted to special requirements and needs.  
More Info on page 25



MOLTO LUCE production hall 1711m<sup>2</sup>  
Mounting height: 5,4m  
Maintained illuminance: 750lx  
Trail light inserts wide beam (90°), mid output (M0), DALI  
Trail customised sensor IR Quattro HD - KNX, light & movement control

# TRAIL

THE FLEXIBLE TRUNKING SYSTEM

## DURCHGANGSVERDRAHTUNG & VERBINDUNSSYSTEM

- individuelle Anordnung aller Lichteinsätze
- hohe Zeitersparnis bei der Montage

## ZUKUNFTSSICHER

- die Anordnung des Systems kann einfach verändert oder erweitert werden

## NEUE LICHTEINSÄTZE & OPTIKEN

- blendfreier Sehkomfort und absolut homogene Lichtverteilung

## NEUE EINSÄTZE FÜR DEN HANDEL – MOVA & ARTIS

- effiziente vertikale Beleuchtung und viele Möglichkeiten der Warenpräsentation

## LICHT & BEWEGUNGSSTEUERUNG

- neue Sensorenfamilie für hohe Energieeinsparung und CO<sub>2</sub> Reduktion

## THROUGH-WIRING & CONNECTION SYSTEM

- individual positioning of all light inserts
- the installation time is dramatically reduced

## FUTUREPROOF

- the arrangement of the system can be easily changed or extended

## NEW LIGHT INSERTS & OPTICS

- high visual comfort without glare and absolute homogeneous light distribution

## NEW RETAIL INSERTS MOVA & ARTIS

- efficient vertical illumination and wide range of goods presentation

## LIGHT & MOVEMENT CONTROL

- new sensor family for high energy saving and CO<sub>2</sub> reduction

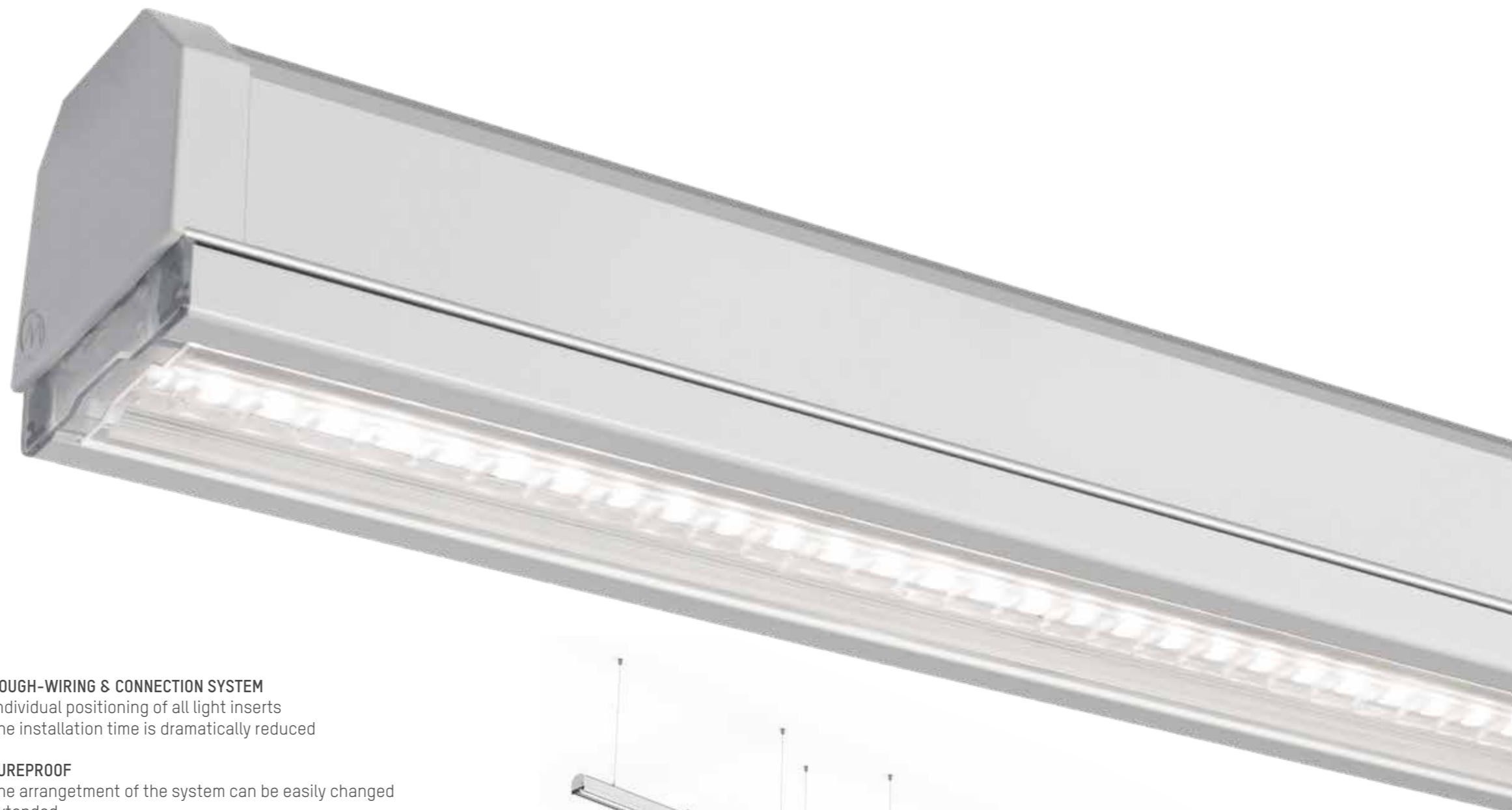

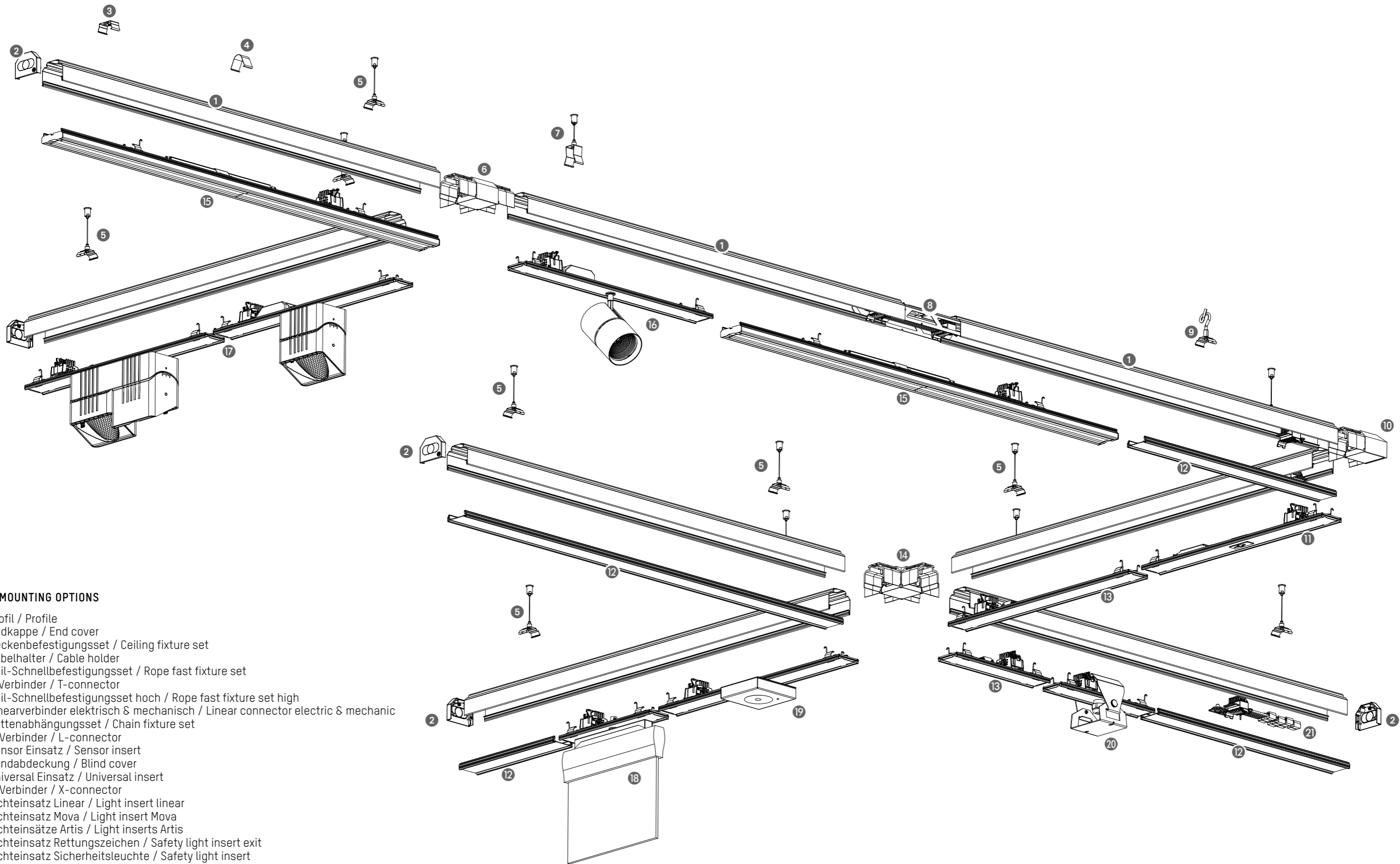

**TRAIL MOUNTING OPTIONS**

- 1 Profil / Profile
- 2 Endkappe / End cover
- 3 Deckenbefestigungsset / Ceiling fixture set
- 4 Kabelhalter / Cable holder
- 5 Seil-Schnellbefestigungsset / Rope fast fixture set
- 6 T-Verbinder / T-connector
- 7 Seil-Schnellbefestigungsset hoch / Rope fast fixture set high
- 8 Linearverbinder elektrisch & mechanisch / Linear connector electric & mechanic
- 9 Kattenabhängungsset / Chain fixture set
- 10 L-Verbinder / L-connector
- 11 Sensor Einsatz / Sensor insert
- 12 Blindabdeckung / Blind cover
- 13 Universal Einsatz / Universal insert
- 14 X-Verbinder / X-connector
- 15 Lichteinsatz Linear / Light insert linear
- 16 Lichteinsatz Mova / Light insert Mova
- 17 Lichteinsätze Artis / Light inserts Artis
- 18 Lichteinsatz Rettungszeichen / Safety light insert exit
- 19 Lichteinsatz Sicherheitsleuchte / Safety light insert
- 20 High Bay Einsatz / High Bay insert
- 21 Einspeisung flexibel / Feed in set flexible



Storage hall: 3500m<sup>2</sup>  
Mounting height: 6m  
Maintained illuminance: 300lx  
Trail light inserts medium beam (60°), high efficiency (HE), DALI

## MOUNTING RAILS

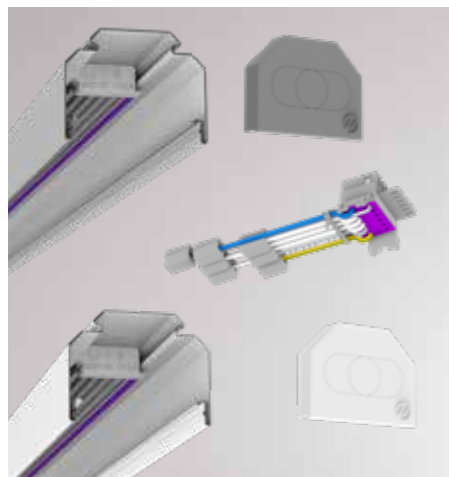

### EINZELTRAGSCHIENE SET | SINGLE MOUNTING RAIL SET

7-pol. Stromführung / 7-pol. current conduction  
Verzinktes Stahlblech / galvanized sheet steel

Bestehend aus Tragschiene, 2 x Enddeckel, Einspeisung flexibel  
Consisting of mounting rail, 2 x end piece, feed in flexible

Achtung: nur in Weiß und Silber erhältlich

Attention: only available in white or silver

610-0401001000XX0 L: 1137mm **7-POLE**

610-0402001000XX0 L: 1696mm **7-POLE**

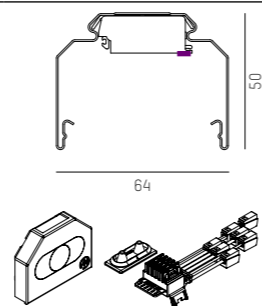

IP20 ⚡ CE

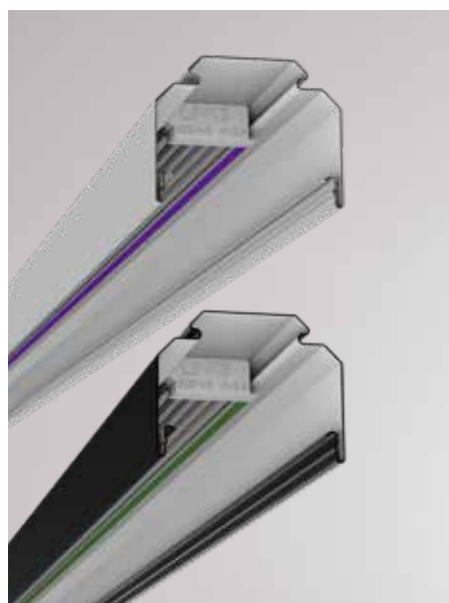

### TRAGSCHIENE | MOUNTING RAIL

7- oder 11 pol. Stromführung / 7- or 11 pol. current conduction  
Verzinktes Stahlblech / galvanized sheet steel

610-0201001000XX0 L: 1137mm **7-POLE**

610-0202001000XX0 L: 1696mm **7-POLE**

610-0203001000XX0 L: 2255mm **7-POLE**

610-0208001000XX0 L: 3392mm **7-POLE**

610-0204001000XX0 L: 4510mm **7-POLE**

610-0201002000XX0 L: 1137mm **11-POLE**

610-0202002000XX0 L: 1696mm **11-POLE**

610-0203002000XX0 L: 2255mm **11-POLE**

610-0208002000XX0 L: 3392mm **11-POLE**

610-0204002000XX0 L: 4510mm **11-POLE**

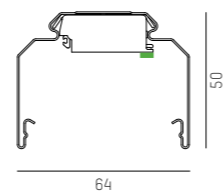
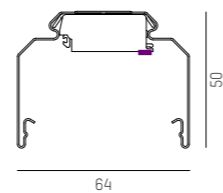

IP20 ⚡ CE

### ARTIKELNUMMER ERGÄNZEN / COMPLETE CODE

XX = FARBE / COLOUR

**S** silver = 04

**W** white = 05

**S** black = 06

Achtung: Nicht bei Einzeltragschienen-Set / Attention: not for single mounting rail set

TRAIL

## FEED IN

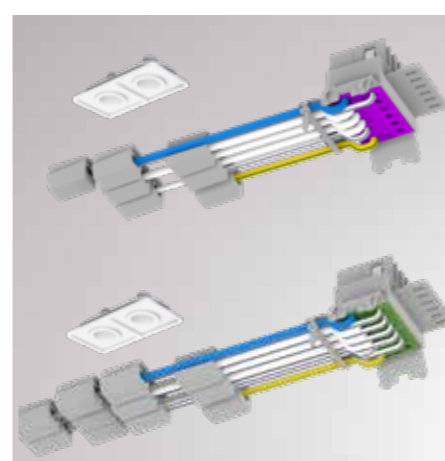

### EINSPEISUNGSSET FLEXIBEL | FEED IN SET FLEXIBLE

Werkzeuglose montage / no tools needed

610-0101001000000

**7-POLE**

610-0101002000000

**11-POLE**

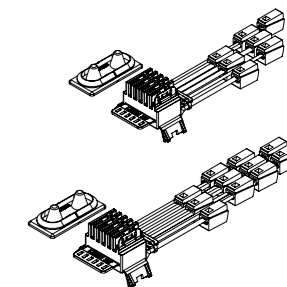
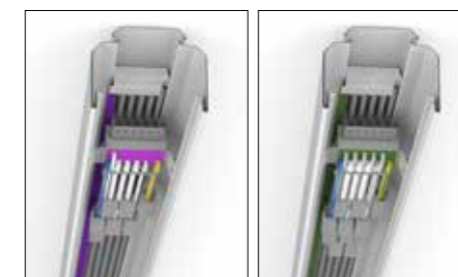

### EINSPEISUNGSSET STARR | FEED IN SET FIX

Werkzeuglose montage / no tools needed

610-0102001000000

**7-POLE**

610-0102002000000

**11-POLE**

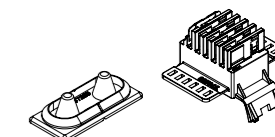
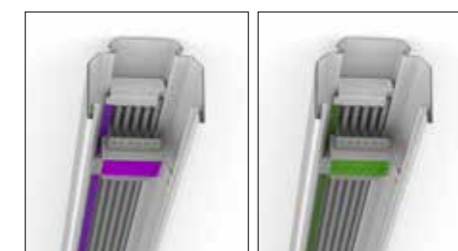

### LINEARVERBINDER ELEKTRISCH | LINEAR CONNECTOR ELECTRIC

Innenliegend, inkl. Schienenverbinder / inside, incl. trail connector

610-0002001000000

**7-POLE**

610-0002002000000

**11-POLE**

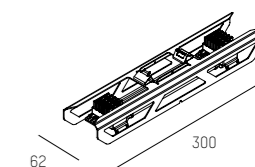

### MONTAGEHILFE FÜR EINSPEISUNGSSET | MOUNTING TOOL FOR FEED IN SET

610-0007000000000

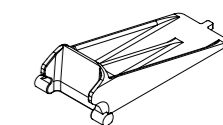

## CONNECTORS

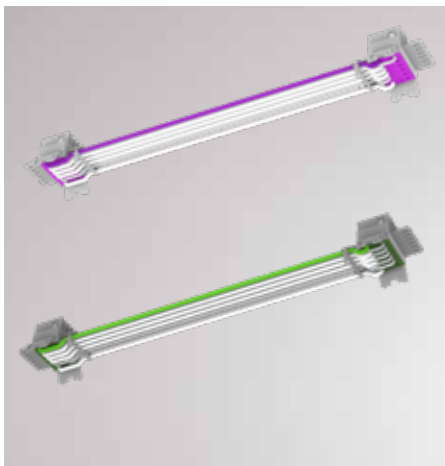

### FLEXVERBINDER ELEKTRISCH | FLEX CONNECTOR ELECTRIC

innenliegend, für T, L, X Verbinder / inside, for T, L, X connector

610-0012001000000

7-POLE

610-0012002000000

11-POLE

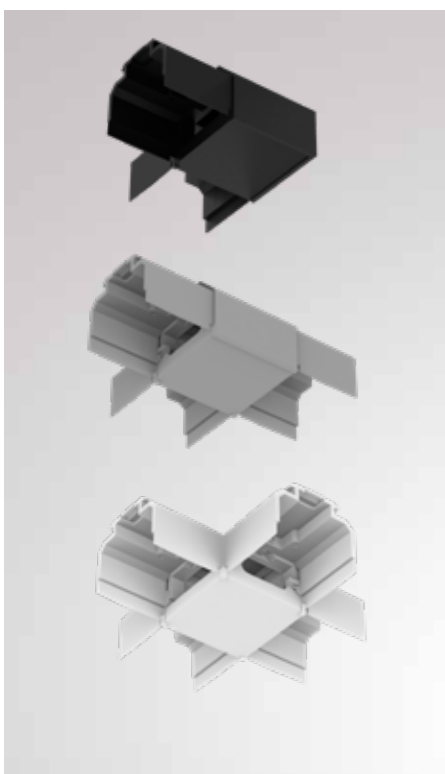
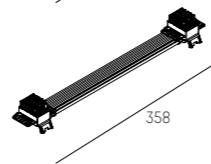
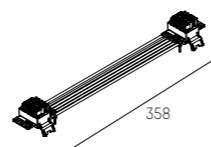

### L / T / X VERBINDER | L / T / X CONNECTOR

außen, Flexverbinder elektrisch separat ordern / outside, order flex connector electric separately

610-0009000000XX0

L-VERBINDER / L-CONNECTOR

610-0010000000XX0

T-VERBINDER / T-CONNECTOR

610-0011000000XX0

X-VERBINDER / X-CONNECTOR

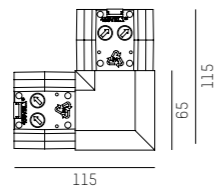

Flexverbinder  
1 Stück ordern

Flexible connector  
order 1 piece

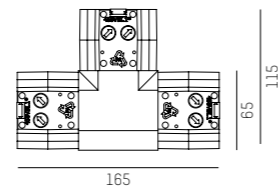

Flexverbinder  
2 Stück ordern

Flexible connector  
order 2 piece

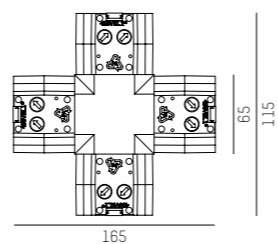

Flexverbinder  
3 Stück ordern

Flexible connector  
order 3 piece

### ARTIKELNUMMER ERGÄNZEN / COMPLETE CODE

XX = FARBE / COLOUR

**s** silver = 04

**w** white = 05

**s** black = 06

## EMPTY RAIL



### TRAGSCHIENE | MOUNTING RAIL

Leermodul ohne Stromführung / empty module without current conduction

Verzinktes Stahlblech / galvanized sheet steel

610-0205000000XX0

L: 4510mm

EMPTY

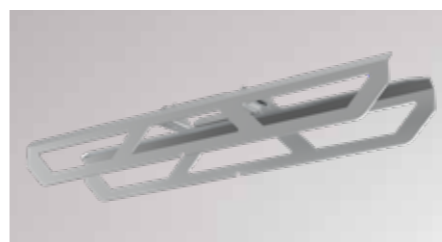
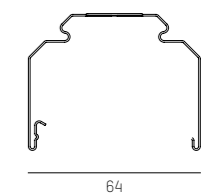
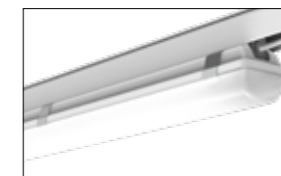

### LINEARVERBINDER MECHANISCH / LINEAR CONNECTOR MECHANIC

innenliegend / inside

610-0023000000000

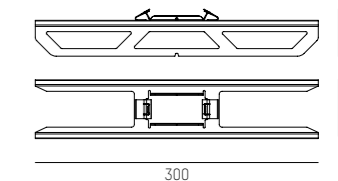

## COVERS

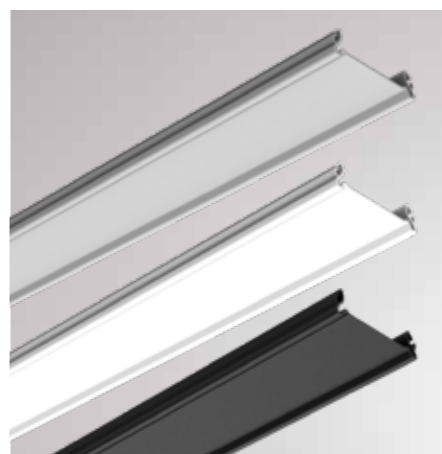

### BLINDABDECKUNG | BLIND COVER

Kunststoff / plastic

610-0231000000XX0

L: 1137mm

610-0237000000XX0

L: 1696mm

610-0232000000XX0

L: 2255mm

610-0233000000XX0

L: 4510mm

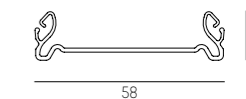
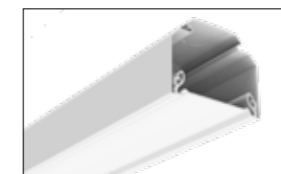

### BLINDABDECKUNG | BLIND COVER

Metall / metal

610-0234000000050

**w**

L: 1137mm

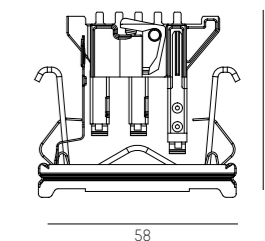
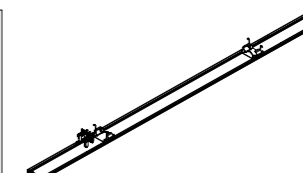
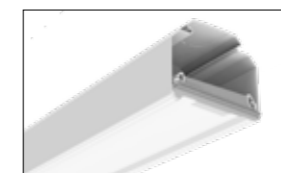

## FIXING COMPONENTS



### DECKENBEFESTIGUNGSSET | CEILING FIXTURE SET

Werkzeuglose montage / no tools needed

610-0003000000000

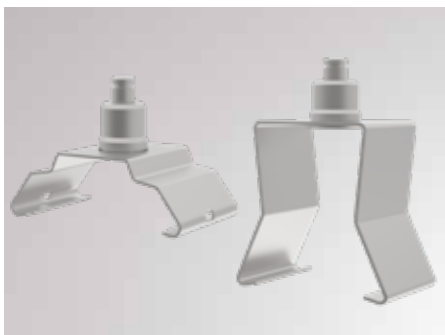
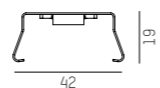

### SEIL-SCHNELLBEFESTIGUNGSSET | ROPE FAST FIXTURE SET

Werkzeuglose montage / no tools needed

610-0004000000000

610-0005000000000 HOCH / HIGH für 25mm Installationsrohr / for 25mm plumbing pipe

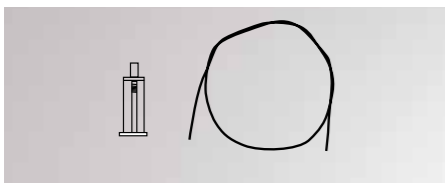
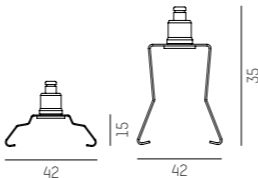

### DECKENBEFESTIGUNGSSET | CEILING FIXTURE SET

Werkzeuglose montage, beliebig kürzbar / no tools needed, cut to any length

610-0022000000000

Ø 1,5mm / L 3000mm

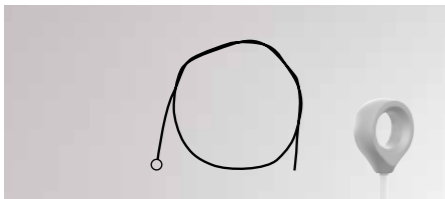

### STAHLSEIL MIT ÖSE | STEEL ROPE WITH LOOP

Werkzeuglose montage, beliebig kürzbar / no tools needed, cut to any length

610-0025000000000

Ø 1,5mm / L 1500mm

610-0026000000000

Ø 1,5mm / L 3000mm

610-0027000000000

Ø 1,5mm / L 6000mm

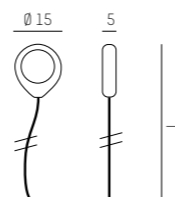

### KETTENBEFESTIGUNGSSET | CHAIN FIXTURE SET

Werkzeuglose montage / no tools needed

610-0006000000000

610-0019000000000 HOCH / HIGH für 25mm Installationsrohr / for 25mm plumbing pipe

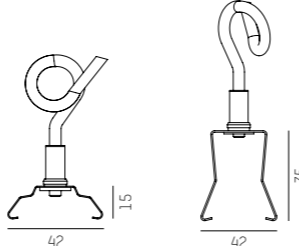
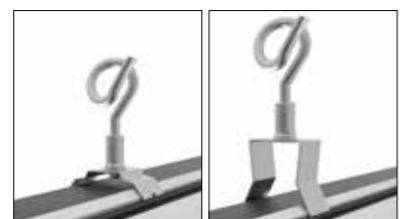

### KETTE | CHAIN

Tragkraft: max. 30kg / Load capacity: max. 30kg

835-9926194

Ø 2,2mm / Meterware / per meter

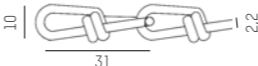

## FIXING COMPONENTS



### CADDY CLIP ABHÄNGUNGSSET | CADDY CLIP SUSPENSION SET

Werkzeuglose montage / no tools needed

610-0018000000000

für Tragschienen 24 - 26mm / for 24 - 26mm mounting rails



## ACCESSOIRES

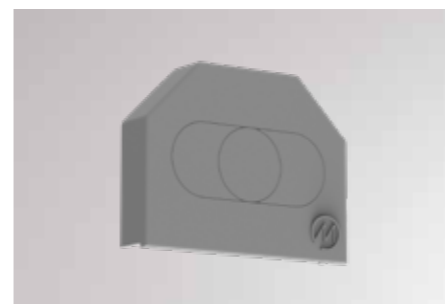

### ENDECKEL | END PIECE

Set 2 Stück / set 2 pcs.

610-0001000000XX0

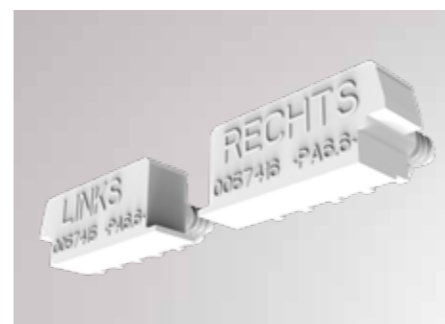
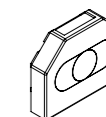

### ENDKAPPE STROMFÜHRUNG INNEN | END PIECE CURRENT INSIDE

Werkzeuglose montage / no tools needed

610-0015000000000

SET LINKS + RECHTS / SET LEFT + RIGHT

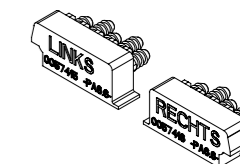
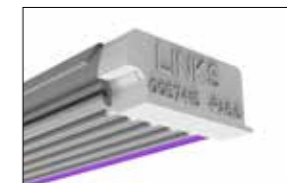

### KABELHALTER | CABLE HOLDER

Werkzeuglose montage / no tools needed

610-0014000000000

INNEN / INSIDE

610-0016000000000

AUSSEN / OUTSIDE

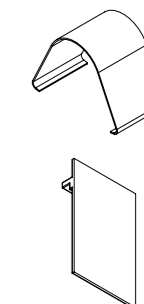

### ARTIKELNUMMER ERGÄNZEN / COMPLETE CODE

XX = FARBE / COLOUR

**S** silver = 04

**W** white = 05

**S** black = 06



LICHTVERTEILUNG | LIGHT BEAM

Effiziente Linsen sorgen für einen blendfreien Sehkomfort und eine absolut homogene Lichtverteilung. TRAIL Lichteinsätze sind verfügbar mit unterschiedlichen Ausstrahlwinkeln für verschiedenste Anwendungsbereiche.

Efficient lenses ensure perfect glare control and absolute homogeneous light distribution. TRAIL light inserts are available with various beam angles for different applications.

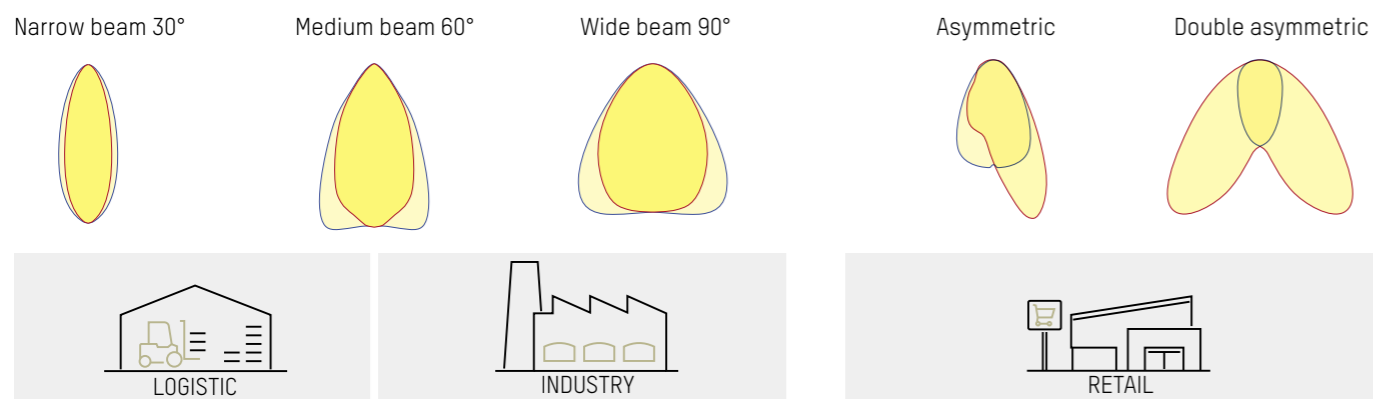

EFFIZIENZ | EFFICIENCY



**HIGH EFFICIENCY LICHTEINSATZ**  
Applikationsspezifische Optiken bis zu UGR<19 sorgen für absolut blendfreie Lichtlösungen und hohe Energieeffizienz (bis zu 180lm/W) zur Reduktion des Stromverbrauchs

**HIGH EFFICIENCY LIGHT INSERT**  
Application-specific optics up to UGR<19 ensure absolutely glare-free lighting solutions and high energy efficiency (up to 180lm/W) to reduce power consumption



**MID OUTPUT LICHTEINSATZ**  
Die optimale Kombination aus Energieeffizienz und Lumen-Output für mittlere Montagehöhen im Industriebereich (z.B. Produktionshallen oder Lagerflächen)

**MID OUTPUT LIGHT INSERT**  
The ideal combination of energy efficiency and lumen-output for medium mounting heights in industrial areas (e.g. production halls or storage areas)



**HIGH OUTPUT LICHTEINSATZ**  
Perfekter Sehkomfort (UGR<22) bei höheren Lumenwerten von bis zu 20.000 lm ermöglicht maximale Effizienz auch für hohe Montageanwendungen

**HIGH OUTPUT LIGHT INSERT**  
Perfect visual comfort (UGR <22) with higher lumen values of up to 20,000 lm possible maximum efficiency even for high assembly applications

TRAIL Lichteinsätze sind mit ON/OFF, DALI und DALI2 Vorschaltgeräten für verschiedene Steuerungsmöglichkeiten bestückt. HIGH OUTPUT Lichteinsätze werden standardmäßig mit DALI2 EVGs mit integrierter Stromversorgung ausgestattet. Die ideale Kombination mit TRAIL Sensoren (Seite 29) ermöglicht es, die leuchtenspezifischen Daten für Predictive Maintenance and Diagnostics zu verwenden.

TRAIL light inserts are equipped with ON / OFF, DALI and DALI2 ballasts for various control options. HIGH OUTPUT light inserts are equipped with DALI2 ECGs with integrated power supply as standard. The ideal combination with TRAIL sensors (page 29) enables the luminaire-specific data to be used for predictive maintenance and diagnostics.



LICHTEINSATZ STANDARD / LIGHT INSERT STANDARD  
220-240V AC 50/60Hz 7-POLE

HIGH EFFICIENCY VERSION



| SYS 25W L: 1137mm | lm   | W3   | W35  | W4   | W5 |
|-------------------|------|------|------|------|----|
| AS                | 3820 | 3820 | 4020 | 4020 |    |
| DAS               | 3820 | 3820 | 4020 | 4020 |    |
| WB                | 4030 | 4030 | 4250 | 4250 |    |
| NB                | 4030 | 4030 | 4250 | 4250 |    |
| MB                | 4160 | 4160 | 4390 | 4390 |    |

| SYS 37W L: 1696mm | lm   | W3   | W35  | W4   | W5 |
|-------------------|------|------|------|------|----|
| AS                | 5730 | 5730 | 6030 | 6030 |    |
| DAS               | 5730 | 5730 | 6030 | 6030 |    |
| WB                | 6050 | 6050 | 6380 | 6380 |    |
| NB                | 6050 | 6050 | 6380 | 6380 |    |
| MB                | 6250 | 6250 | 6580 | 6580 |    |

| SYS 49W L: 2255mm | lm   | W3   | W35  | W4   | W5 |
|-------------------|------|------|------|------|----|
| AS                | 7640 | 7640 | 8050 | 8050 |    |
| DAS               | 7640 | 7640 | 8050 | 8050 |    |
| WB                | 8070 | 8070 | 8510 | 8510 |    |
| NB                | 8070 | 8070 | 8510 | 8510 |    |
| MB                | 8330 | 8330 | 8780 | 8780 |    |

Systemeinsatz in 3 Längen · Oberfläche pulverbeschichtet · 5 verschiedene Abstrahlcharakteristiken · Mit hoher Energieeffizienz · Schaltbar oder DALI dimmbar

System inserts in 3 different lengths · surface powder-coated · 5 different beam options · with high energy efficiency · switchable or DALI dimmable

Insero per sistema in 3 diverse lunghezze · superficie verniciata a polvere · 5 diversi fasci d'apertura · ad alta efficienza energetica · on off o dimmerabile DALI

Inserts lumineux pour système, disponibles en 3 longueurs · Revêtement par poudre · 5 angles de rayonnement · Haute efficacité énergétique · Commutables ou gradables DALI

**ACHTUNG: Lumenangaben nur für weißen Lichteinsatz! Info für silber und schwarz siehe QR-Code**



**ATTENTION: Lumeninfo only for white light insert! Info for silver and black look at QR-Code**

LED 5000K auf Anfrage / on request

IP20 CE



| ARTIKELNUMMER ERGÄNZEN / COMPLETE CODE   |                                |                     |                        |
|--|--------------------------------|---------------------|------------------------|
| R = ABSTRAHLUNG / BEAM                   | WW = LICHTFARBE / LIGHT COLOUR | XX = FARBE / COLOUR | Y = DIMMBAR / DIMMABLE |
| AS Asymm. / asymm. = 1                   | W3 LED 3000K = 19 CRI>80       | S silver = 04       | S switchable = 0       |
| DAS Doppelasymm. / double asymm. = 2     | W35 LED 3500K = 17 CRI>80      | W white = 05        | D DALI dimm. = d       |
| WB Breitstrahlend / wide beam 90° = 3    | W4 LED 4000K = 14 CRI>80       | S black = 06        |                        |
| NB Tiefstrahlend / narrow beam 30° = 4   | W5 LED 6500K = 16 CRI>80       |                     |                        |
| MB Mediumstrahlend / medium beam 60° = 5 |                                |                     |                        |

## MID OUTPUT LIGHT INSERTS



### LICHTEINSATZ STANDARD / LIGHT INSERT STANDARD

220-240V AC 50/60Hz 7-POLE

#### MID OUTPUT VERSION



| SYS 40W L: 1137mm | lm   | W3   | W3S  | W4   | W5   |
|-------------------|------|------|------|------|------|
| AS                | 5940 | 5940 | 6260 | 6260 |      |
| DAS               | 5940 | 5940 | 6260 | 6260 |      |
| 610-1251021RWWXXY | WB   | 6280 | 6280 | 6620 | 6620 |
|                   | NB   | 6280 | 6280 | 6620 | 6620 |
|                   | MB   | 6480 | 6480 | 6830 | 6830 |

| SYS 60W L: 1696mm | lm   | W3   | W3S  | W4    | W5    |
|-------------------|------|------|------|-------|-------|
| AS                | 8910 | 8910 | 9390 | 9390  |       |
| DAS               | 8910 | 8910 | 9390 | 9390  |       |
| 610-1252021RWWXXY | WB   | 9420 | 9420 | 9930  | 9930  |
|                   | NB   | 9420 | 9420 | 9930  | 9930  |
|                   | MB   | 9720 | 9720 | 10250 | 10250 |

| SYS 80W L: 2255mm | lm    | W3    | W3S   | W4    | W5    |
|-------------------|-------|-------|-------|-------|-------|
| AS                | 11880 | 11880 | 12520 | 12520 |       |
| DAS               | 11880 | 11880 | 12520 | 12520 |       |
| 610-1253021RWWXXY | WB    | 12560 | 12560 | 13240 | 13240 |
|                   | NB    | 12560 | 12560 | 13240 | 13240 |
|                   | MB    | 12960 | 12960 | 13660 | 13660 |



**ACHTUNG:** Lumenangaben nur für weißen Lichteinsatz!  
Info für silber und schwarz siehe QR-Code

**ATTENTION:** Lumeninfo only for white light insert!  
Info for silver and black look at QR-Code

LED 5000K auf Anfrage / on request

IP20 Ⓢ CE



| ARTIKELNUMMER ERGÄNZEN / COMPLETE CODE   |                                |                     |                        |
|--|--------------------------------|---------------------|------------------------|
| R = ABSTRAHLUNG / BEAM                   | WW = LICHTFARBE / LIGHT COLOUR | XX = FARBE / COLOUR | Y = DIMMBAR / DIMMABLE |
| AS Asymm. / asymm. = 1                   | W3 LED 3000K = 19 CRI>80       | S silver = 04       | Ⓢ switchable = 0       |
| DAS Doppelasymm. / double asymm. = 2     | W3S LED 3500K = 17 CRI>80      | W white = 05        | Ⓣ DALI dimm. = d       |
| WB Breitstrahlend / wide beam 90° = 3    | W4 LED 4000K = 14 CRI>80       | S black = 06        |                        |
| NB Tiefstrahlend / narrow beam 30° = 4   | W5 LED 6500K = 16 CRI>80       |                     |                        |
| MB Mediumstrahlend / medium beam 60° = 5 |                                |                     |                        |

## HIGH OUTPUT LIGHT INSERTS



### LICHTEINSATZ STANDARD / LIGHT INSERT STANDARD

220-240V AC 50/60Hz 7-POLE

#### HIGH OUTPUT VERSION



| SYS 61W L: 1137mm | lm   | W3   | W3S  | W4   | W5   |
|-------------------|------|------|------|------|------|
| AS                | 8540 | 8540 | 9010 | 9010 |      |
| DAS               | 8540 | 8540 | 9010 | 9010 |      |
| 610-1251031RWWXXY | WB   | 9030 | 9030 | 9520 | 9520 |
|                   | NB   | 9030 | 9030 | 9520 | 9520 |
|                   | MB   | 9320 | 9320 | 9830 | 9830 |

| SYS 92W L: 1696mm | lm    | W3    | W3S   | W4    | W5    |
|-------------------|-------|-------|-------|-------|-------|
| AS                | 12820 | 12820 | 13520 | 13520 |       |
| DAS               | 12820 | 12820 | 13520 | 13520 |       |
| 610-1252031RWWXXY | WB    | 13550 | 13550 | 14280 | 14280 |
|                   | NB    | 13550 | 13550 | 14280 | 14280 |
|                   | MB    | 13980 | 13980 | 14750 | 14750 |

| SYS 122W L: 2255mm | lm    | W3    | W3S   | W4    | W5    |
|--------------------|-------|-------|-------|-------|-------|
| AS                 | 17090 | 17090 | 18020 | 18020 |       |
| DAS                | 17090 | 17090 | 18020 | 18020 |       |
| 610-1253031RWWXXY  | WB    | 18070 | 18070 | 19050 | 19050 |
|                    | NB    | 18070 | 18070 | 19050 | 19050 |
|                    | MB    | 18650 | 18650 | 19660 | 19660 |



**ACHTUNG:** Lumenangaben nur für weißen Lichteinsatz!  
Info für silber und schwarz siehe QR-Code

**ATTENTION:** Lumeninfo only for white light insert!  
Info for silver and black look at QR-Code

LED 5000K auf Anfrage / on request

IP20 Ⓢ CE



| ARTIKELNUMMER ERGÄNZEN / COMPLETE CODE   |                                |                     |                              |
|--|--------------------------------|---------------------|------------------------------|
| R = ABSTRAHLUNG / BEAM                   | WW = LICHTFARBE / LIGHT COLOUR | XX = FARBE / COLOUR | Y = DIMMBAR / DIMMABLE       |
| AS Asymm. / asymm. = 1                   | W3 LED 3000K = 19 CRI>80       | S silver = 04       | Ⓢ switchable = 0             |
| DAS Doppelasymm. / double asymm. = 2     | W3S LED 3500K = 17 CRI>80      | W white = 05        | Ⓣ DALI 2 incl. PSU dimm. = 2 |
| WB Breitstrahlend / wide beam 90° = 3    | W4 LED 4000K = 14 CRI>80       | S black = 06        |                              |
| NB Tiefstrahlend / narrow beam 30° = 4   | W5 LED 6500K = 16 CRI>80       |                     |                              |
| MB Mediumstrahlend / medium beam 60° = 5 |                                |                     |                              |



EUROGAST / Leibnitz / Austria  
Sales area, accent lighting  
Mounting height: 3,2m  
Trail Spot light insert  
Trail light insert medium beam (60°), high efficiency (HE)

## SPOT LIGHT INSERTS



### LICHTEINSATZ MOVA / LIGHT INSERT MOVA

220-240V AC 50/60Hz **7-POLE**

| SYS 27W | lm   | W3   | W35  | W4 |
|---------|------|------|------|----|
| AS      | 2770 | 2540 | 2900 |    |
| 17°     | 2770 | 2540 | 2900 |    |
| 24°     | 2770 | 2540 | 2900 |    |
| 40°     | 2770 | 2540 | 2900 |    |
| 60°     | 2770 | 2540 | 2900 |    |

| SYS 31W | lm   | W3   | W35  | W4 |
|---------|------|------|------|----|
| AS      | 3100 | 2840 | 3250 |    |
| 17°     | 3100 | 2840 | 3250 |    |
| 24°     | 3100 | 2840 | 3250 |    |
| 40°     | 3100 | 2840 | 3250 |    |
| 60°     | 3100 | 2840 | 3250 |    |

| SYS 40W | lm   | W3   | W35  | W4 |
|---------|------|------|------|----|
| AS      | 4100 | 3840 | 4300 |    |
| 24°     | 4100 | 3840 | 4300 |    |
| 40°     | 4100 | 3840 | 4300 |    |

Strahlereinsatz · Oberfläche pulverbeschichtet · 5 verschiedene Abstrahlcharakteristiken · Schaltbar oder DALI dimmbar

Spot inserts · surface powder-coated · 5 different beam options · switchable or DALI dimmable

Inserto spot · superficie verniciata a polvere · 5 diversi fasci d'apertura · on off o dimmerabile DALI

Inserts avec spots · Revêtement par poudre · 5 angles de rayonnement · Commutables ou gradables DALI

IP20

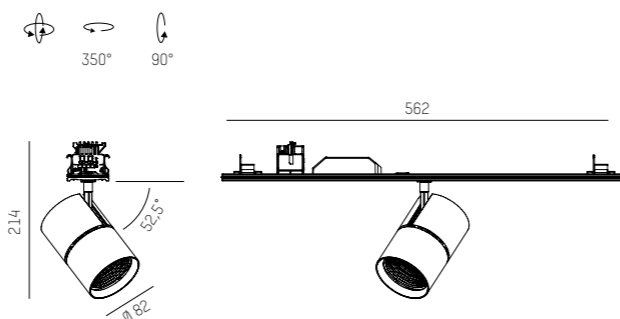

#### ARTIKELNUMMER ERGÄNZEN / COMPLETE CODE

| R = ABSTRAHLUNG / BEAM | WW = LICHTFARBE / LIGHT COLOUR    | XX = FARBE / COLOUR | Y = DIMMBAR / DIMMABLE |
|------------------------|-----------------------------------|---------------------|------------------------|
| AS Asymm. / asymm. = 1 | W3 LED 3000K = 49 PREMIUM CRI>90  | S silver = 44       | S switchable = 0       |
| 17° Spot = 4           | W35 LED 3500K = 47 PREMIUM CRI>90 | W white = 55        | D DALI dimm. = d       |
| 24° Medium = 5         | W4 LED 4000K = 24 CRI>90          | S black = 66        |                        |
| 40° Flood = 3          |                                   |                     |                        |
| 60° Wideflood = 6      |                                   |                     |                        |

## SPOT LIGHT INSERTS

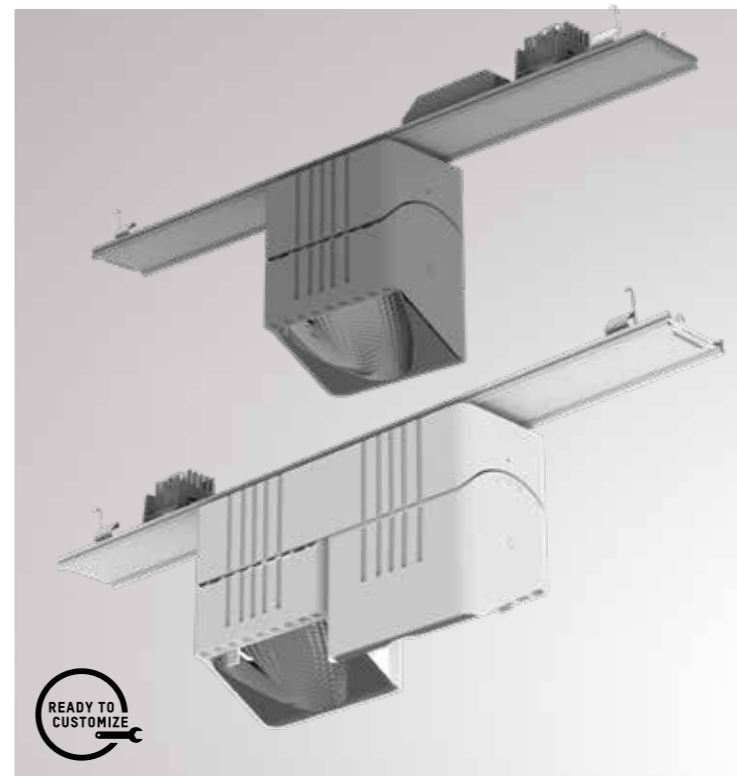

### LICHTEINSATZ ARTIS / LIGHT INSERT ARTIS

220-240V AC 50/60Hz **7-POLE**

#### 1-flammig / 1-flame

| SYS 40W           | lm | W3   | W35  | W4   |
|-------------------|----|------|------|------|
| 610-03510111WWXXY | AS | 3880 | 3940 | 4390 |

#### 2-flammig / 2-flame

| SYS 80W           | lm  | W3   | W35  | W4   |
|-------------------|-----|------|------|------|
| 610-03520112WWXXY | DAS | 7760 | 7890 | 8780 |

### LICHTEINSATZ ARTIS MATRIX / LIGHT INSERT ARTIS MATRIX

220-240V AC 50/60Hz **7-POLE**

#### 1-flammig / 1-flame

| SYS 40W           | MATRIX | lm   | W3   | W35  | W4 |
|-------------------|--------|------|------|------|----|
| 610-03510311WWXXY | AS     | 3880 | 3940 | 4390 |    |

Strahlereinsatz · Oberfläche pulverbeschichtet · Standard oder MATRIX Version · 1- oder 2-flammige Ausführung · Schaltbar oder DALI dimmbar

Spot inserts · surface powder-coated · Standard or MATRIX version · 1- or 2-flame option · switchable or DALI dimmable

Inserto spot · superficie verniciata a polvere · standard o versione MATRIX · on off o dimmerabile DALI

Inserts avec spots · Revêtement par poudre · Version standard ou MATRIX · Versions 1 ou 2 spots · Commutables ou gradables DALI

IP20

#### 2-flammig / 2-flame

| SYS 80W           | MATRIX | lm   | W3   | W35  | W4 |
|-------------------|--------|------|------|------|----|
| 610-03520312WWXXY | DAS    | 7760 | 7890 | 8780 |    |

#### INFO ARTIS MATRIX

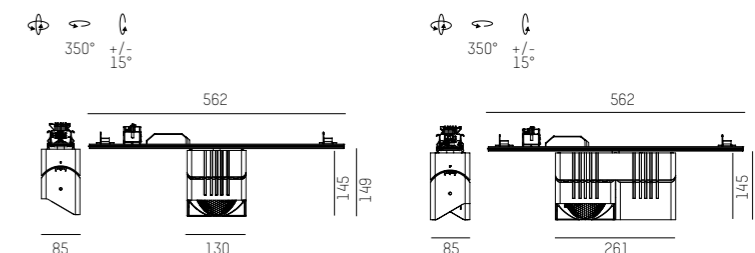

#### ARTIKELNUMMER ERGÄNZEN / COMPLETE CODE

| WW = LICHTFARBE / LIGHT COLOUR    | XX = FARBE / COLOUR | Y = DIMMBAR / DIMMABLE |
|-----------------------------------|---------------------|------------------------|
| W3 LED 3000K = 49 PREMIUM CRI>90  | S silver = 44       | S switchable = 0       |
| W35 LED 3500K = 47 PREMIUM CRI>90 | W white = 55        | D DALI dimm. = d       |
| W4 LED 4000K = 24 CRI>90          | S black = 66        |                        |

## SAFETY LIGHT INSERTS



### LICHTEINSATZ RETTUNGSZEICHEN SAFETY LIGHT INSERT EXIT

220-240V AC 50/60Hz AKKU 3H

SYS 1,7W

610-0271002000XX0 11-POLE

Rettungszeichenleuchte · Gehäuse aus selbstverlöschendem Kunststoff · Aufladezeit: 12h · Erkennungsreichweite 32m · inkl. Piktogramm (1x links, 1x rechts, 2x nach unten)

Safety escape luminaire · housing made of self-extinguishing synthetic · charging time: 12h · detection range 32m · incl. pictogram (1xleft, 1x right, 2x downward)

Lampada di emergenza · scatola in plastica autoestinguente · tempo di ricarica: 12 h · campo di rilevamento 32m · con pittogramma (1 a sinistra, 1 a destra, 2 verso il basso)

Lampe de secours · boîtier en plastique auto-extinguible · temps de charge: 12 h · plage de détection 32m · avec pictogrammes (un à gauche, un à droite et 2 sur le dessous)

IP20

350°

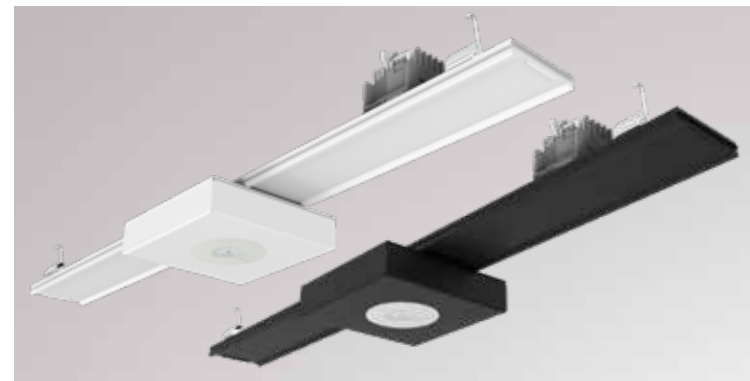
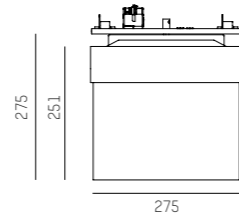

### LICHTEINSATZ SICHERHEITSLEUCHE SAFETY LIGHT INSERT

220-240V AC 50/60Hz AKKU 3H

SYS 6W

610-0272002000XX0 11-POLE

Sicherheitsleuchten-Systemeinsatz · Akkulaufzeit 3h · inkl. Linse für Fluchtwegausleuchtung und Antipanikbeleuchtung · Abstand zwischen Leuchten 21m für eine normgerechte Ausleuchtung von 1lx

Safety luminaire system insert · 3 hour battery life · incl. lens for escape route lighting and anti-panic lighting, distance between luminaires 21m for standard illumination of 1lx (maintained)

Inserto luce di emergenza per sistema · durata batteria 3h · incluso di lenti per segnalazione uscita di emergenza e luce antipanico · distanza utile tra le lampade clabate in emergenza pari a 21m nel rispetto dello standard di illuminamento di 1lx (permanente)

Insert lumineux de secours pour système · Durée de la batterie 3h · y compris les lentilles de signalisation de secours et la lumière anti-panique · distance utile entre les lampes d'urgence de 21m pour le maintien de 1 lux au sol

IP20

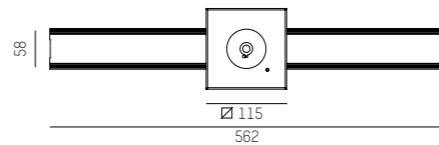

#### ARTIKELNUMMER ERGÄNZEN / COMPLETE CODE

XX = FARBE / COLOUR

silver = 04

white = 05

black = 06



Sie möchten die TRAIL Performance auch in anderen Kombinationen für Ihre Anwendung einsetzen?

Kein Problem - TRAIL System ist individuell konfigurierbar. Auf Wunsch lassen sich alle gekennzeichneten Standardkomponenten an individuelle Bedürfnisse anpassen. Längen, Lichtströme sowie Lichtfarben sind adaptierbar, um mit TRAIL unterschiedlichste Anforderungen normkonform zu erfüllen.

Would you like to use TRAIL Performance in other combinations for your application?

No problem - the TRAIL system can be configured individually. Upon request, all of the standard components marked can be adapted to individual needs. Lengths, luminous fluxes and light colors can be adapted in order to meet the most diverse requirements with TRAIL in compliance with standards.

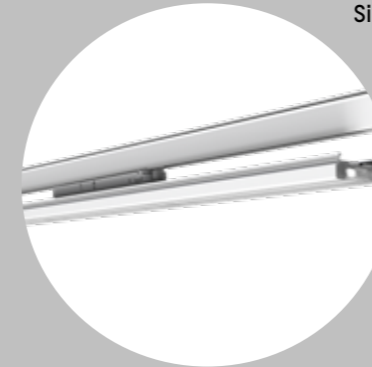

Verfügen Sie bereits über eine Sicherheitsbeleuchtungsanlage?

Auf Wunsch können bereits existierende Not- und Sicherheitsleuchten an das TRAIL System adaptiert werden. Dadurch senken sie ihr Investitionsvolumen und fördern die Nachhaltigkeit.

Do you already have a safety lighting system?

Existing safety lights can be adapted to the TRAIL system on request. In this way, you can reduce your investment volume and promote sustainability.



Seien Sie Ihrer Konkurrenz bei der Warenpräsentation einen Schritt voraus!

TRAIL bietet im Bereich Shop & Retail eine Vielzahl an Kombinationen von Optiken, Lichtfarben und Lumenoutput, welche Ihre Waren perfekt in Szene setzen.

Be one step ahead of your competitors when it comes to the presentation of your goods!

In the shop & retail sector, TRAIL offers a variety of combinations of optics, light colors and lumen output, which perfectly presents your goods.



## HIGH-BAY INSERT

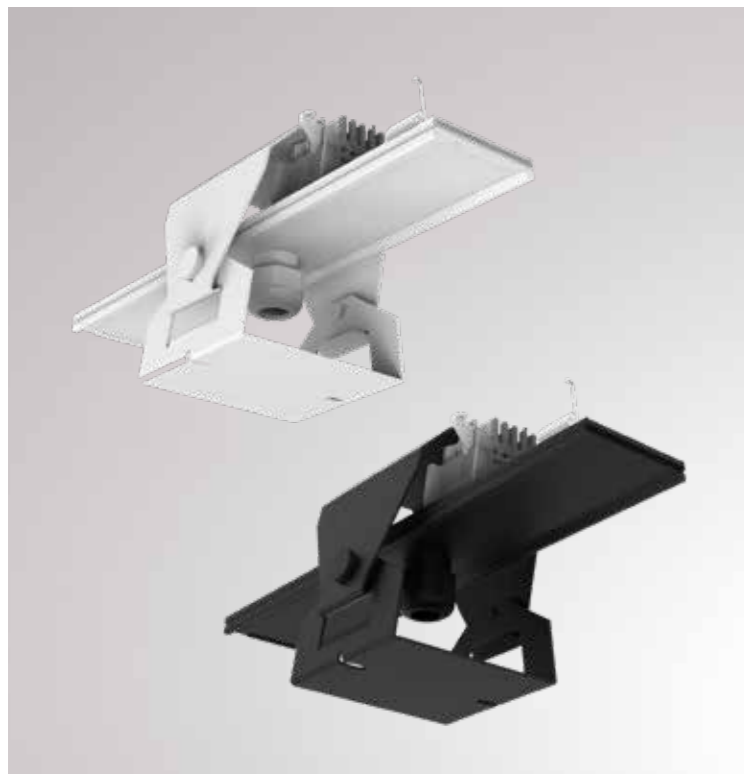

### HIGH-BAY EINSATZ / HIGH-BAY INSERT

220-240V AC 50/60Hz

#### HIGH-BAY

610-0275001000XX0 **7-POLE**  
610-0275002000XX0 **11-POLE**

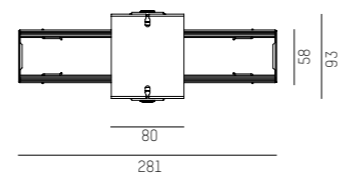

Symbolic photo

Systemeinsatz zur mechanischen Anbindung der kreisförmigen High Bay Leuchte an Trail - Tragkraft: bis zu 10kg - Pro Position eine Abhängung notwendig

System insert for the mechanical connection of the round High Bay luminaire to Trail - Max. load: up to 10kg - One suspension required per position

Inserto per sistema per collegamento meccanico dell'apparecchio circolare High Bay a Trail - Portata: fino a 10kg - Una sospensione necessaria per ciascuna lampada

Insert de système pour la connexion mécanique du luminaire circulaire High Bay à Trail - Capacité de charge : jusqu'à 10kg - Une suspension nécessaire par position

IP20

#### ARTIKELNUMMER ERGÄNZEN / COMPLETE CODE

XX = FARBE / COLOUR

- S silver = 04
- W white = 05
- S black = 06

TRAIL

## UNIVERSAL INSERTS



### UNIVERSAL EINSATZ / UNIVERSAL INSERT

220-240V AC 50/60Hz

für Pendelleuchten oder Strahler (separat ordern)  
for pendants or spots (order separately)

#### L: 281mm

610-0291001000XX0 **7-POLE**  
610-0291002000XX0 **11-POLE**

#### L: 562mm

610-0292001000XX0 **7-POLE**  
610-0292002000XX0 **11-POLE**

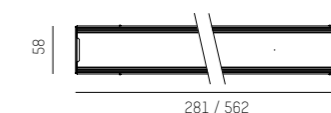

Universaleinsatz - Oberfläche pulverbeschichtet - zum Bestücken mit Sensoren, Notlichtleuchten, Lautsprechern, Spots oder Pendelleuchten (bauseits) - 2 Längen erhältlich - mit Verbindungsklemme bis 5 x 2,5mm<sup>2</sup>

Universal insert - surface powder-coated - for mounting with sensors, safety luminaires, speakers, pendants or spots (on site) - 2 lengths available - with connecting clamp up to 5 x 2,5mm<sup>2</sup>

Inserto universale - superficie verniciata a polvere - da equipaggiare con sensori, luci di emergenza, altoparlanti o apparecchi a sospensione (in loco) - 2 lunghezze disponibili - con morsettiera di collegamento fino a 5 x 2,5mm<sup>2</sup>

Inserts universels - Revêtement par poudre - Possibilité d'ajouter des capteurs, luminaires de secours, haut-parleurs ou suspensions (à fournir par le client) - 2 longueurs disponibles - avec borne de connexion jusqu'à 5 x 2,5mm<sup>2</sup>

IP20

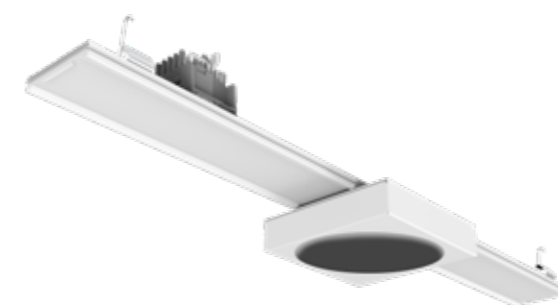

Symbolic photo

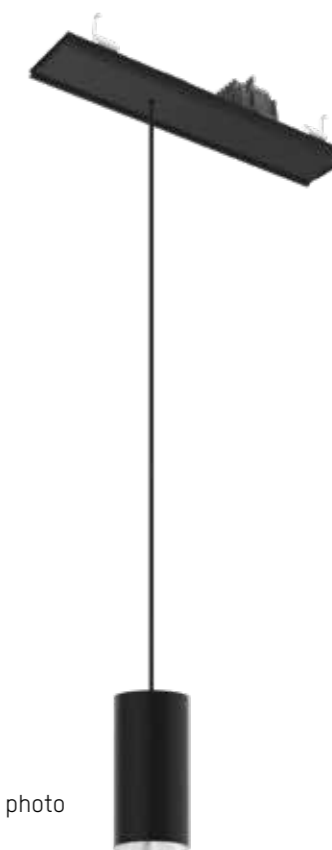

#### ARTIKELNUMMER ERGÄNZEN / COMPLETE CODE

XX = FARBE / COLOUR

- S silver = 04
- W white = 05
- S black = 06

## SENSOR INSERTS

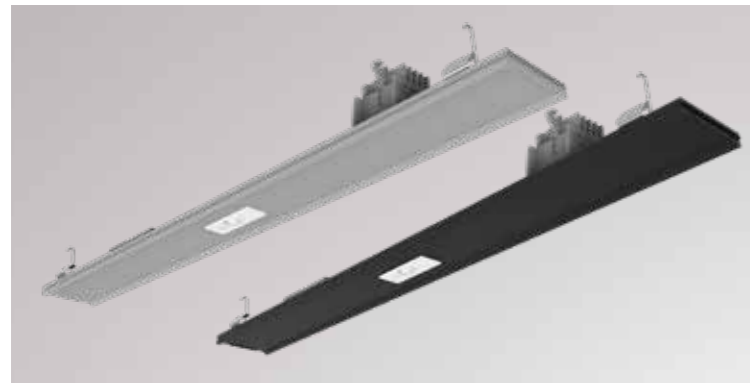

### SENSOR EINSATZ / SENSOR INSERT

220-240V AC 50/60Hz

#### SENSOR

610-0274001000XXk **7-POLE**  
610-0274002000XXk **11-POLE**

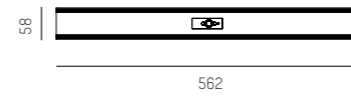

2-Kanal-Lichtsteuergerät mit DALI-Schnittstelle · Anschluss für bis zu 32 elektronische Vor-schaltgeräte möglich · Licht- & Präzsenzsensor · Präsenzerfassungsbereich über integrierte Shutter zwischen 40 - 90° einstellbar · Integrierter Infrarot Empfänger · maximale Installations-höhe 5m

2 channel light control with DALI interface · Suitable for up to 32 electronic control gears · Daylight-dependent regulation and presence-dependent control of light · Presence detection angle adjustable between 40 - 90° via integrated shutters · integrated IR-Receiver · max. Installation height 5m

Regolazione della luce a 2 canali con interfaccia DALI · collegabile a massimo 32 alimentatori elettronici · regolazione luce diurna e sensore di presenza · area rilevazione presenza rego-labile da 40 a 90° tramite deflettore integrato · ricevitore IR integrato · altezza di installazione max. 5m

Gestion de l'éclairage par 2 canaux avec interface DALI · Possibilité de raccorder jusqu'à 32 drivers · Capteur de présence et de lumière · Définition de la zone de détection de présence par le biais de clapets intégrés réglables de 40 à 90° · Récepteur infrarouge intégré · Hauteur d'installation max. 5m

IP20

#### SENSOR

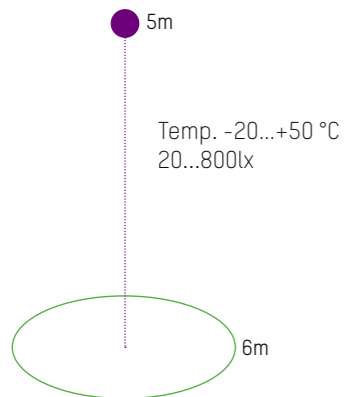

Mögliche Montagehöhe: max. 5m  
Grün: Erfassungsbereich  
Arbeitsbereich Lichtsensor: 20 - 800lx  
Erfassungswinkel: 80°

Possible mounting height: max. 5m  
Green: Detection area  
Workspace light sensor: 20 - 800lx  
Detection area: 80°

#### ARTIKELNUMMER ERGÄNZEN / COMPLETE CODE

**XX** = FARBE / COLOUR

silver = **04**  
 white = **05**  
 black = **06**

## MOTION DETECTOR INSERTS



INTEGRATED DALI POWER SUPPLY  
BLUETOOTH MESH NETWORK

### BEWEGUNGSMELDER EINSATZ MOTION DETECTOR INSERT

220-240V AC 50/60Hz

#### MOTION DETECTOR SENSOR 3360

610-027800100005m **7-POLE** WITH DALI PSU\*  
610-027800200005m **11-POLE** WITH DALI PSU\*  
610-027900100005m **7-POLE** WITHOUT DALI PSU\*  
610-027900200005m **11-POLE** WITHOUT DALI PSU\*

Sensor ausgelegt als DALI-2 Application Controller, direkt an DALI-Bus anschliessbar · Mesh-Netzwerk zur Vernetzung der Sensoren · Parametrierung und Konfiguration via Bluetooth-App · Konstantlicht-Regelung, Vordefinierte Szenen, Haupt- und Grundlicht frei Einstellbar · Freie Definition von Leuchtengruppen mit konfigurierbarem Verhalten · Bis zu 16 DALI LED Treiber anschließbar · einfacher Sensortausch mit Zhaga Schnittstelle

Sensor with integrated DALI2 application controller, Direct connection to a DALI interface · Mesh network for interconnecting sensors · Parameterization and configuration via Bluetooth app · Constant-lighting control, any selectable main and basic light level · User-defined lighting groups with configurable behavior · Suitable for up to 16 DALI-2 LED driver · easy sensor exchange with Zhaga interface

Sensore concepito come controller di applicazioni DALI -2 · Funzione di rete per collegamento sensori · Parametrizzazione e configurazione tramite app Bluetooth · Controllo luce, impostazione scene predefinite, regolazione luce principale ed ambientale · Possibilità di creare gruppi di lampade con funzioni configurabili · Collegabile fino a 16 alimentatori DALI - easy Sensor exchange tramite connessione Zhaga

Capteur conçu comme un contrôleur d'application DALI-2, directement connectable au bus DALI · Réseau maillé pour la mise en réseau des capteurs · Paramétrage et configuration via l'application Bluetooth · Contrôle de la lumière constante, scènes prédéfinies, lumière principale et ambiante librement réglables · Définition libre de groupes de luminaires avec comportement configurable · Jusqu'à 16 pilotes de LED DALI connectables · Échange facile des capteurs comme la connexion Zhaga

IP20

#### MOTION DETECTOR 3360

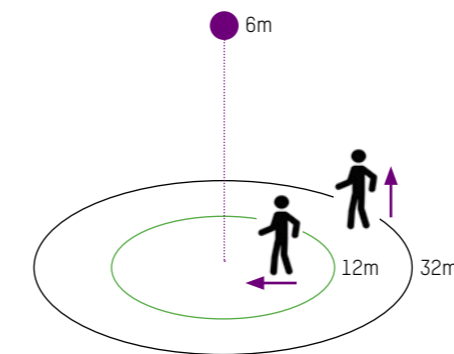

Mögliche Montagehöhe: 2.80 m - 14.00m  
Grün: radial / Schwarz: tangential

Possible mounting height: 4.00 m - 14.00m  
Green: radial / Black: tangential

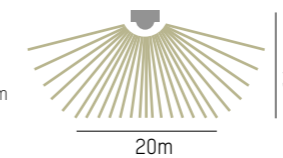

| Montagehöhe / Mounting height | Erfassungsbereich / Detection Area |
|-------------------------------|------------------------------------|
| 14 m                          | Ø 20m (tangential)                 |
| 9 m                           | Ø 28m (tangential)                 |
| 6 m                           | Ø 32m (tangential)                 |
| 2 m                           | Ø 36m (tangential)                 |

#### MOTION DETECTOR 345

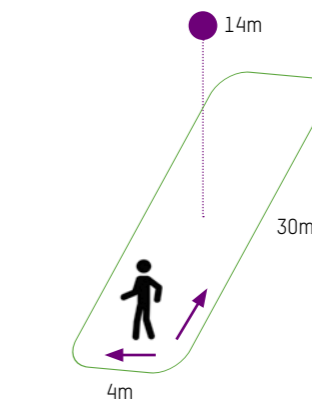

Mögliche Montagehöhe: 4.00 m - 14.00m  
Grün: radial und tangential

Possible mounting height: 4.00 m - 14.00m  
Green: radial and tangential

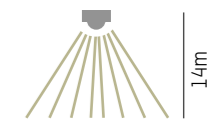

| Montagehöhe / Mounting height | Erfassungsbereich / Detection Area |
|-------------------------------|------------------------------------|
| 14 m                          | 30 m x 4 m                         |
| 10 m                          | 25 m x 4 m                         |
| 8 m                           | 20 m x 4 m                         |
| 6 m                           | 15 m x 4 m                         |
| 4 m                           | 10 m x 4 m                         |



Inbetriebnahme erfolgt via BLUETOOTH  
Commissioning via BLUETOOTH

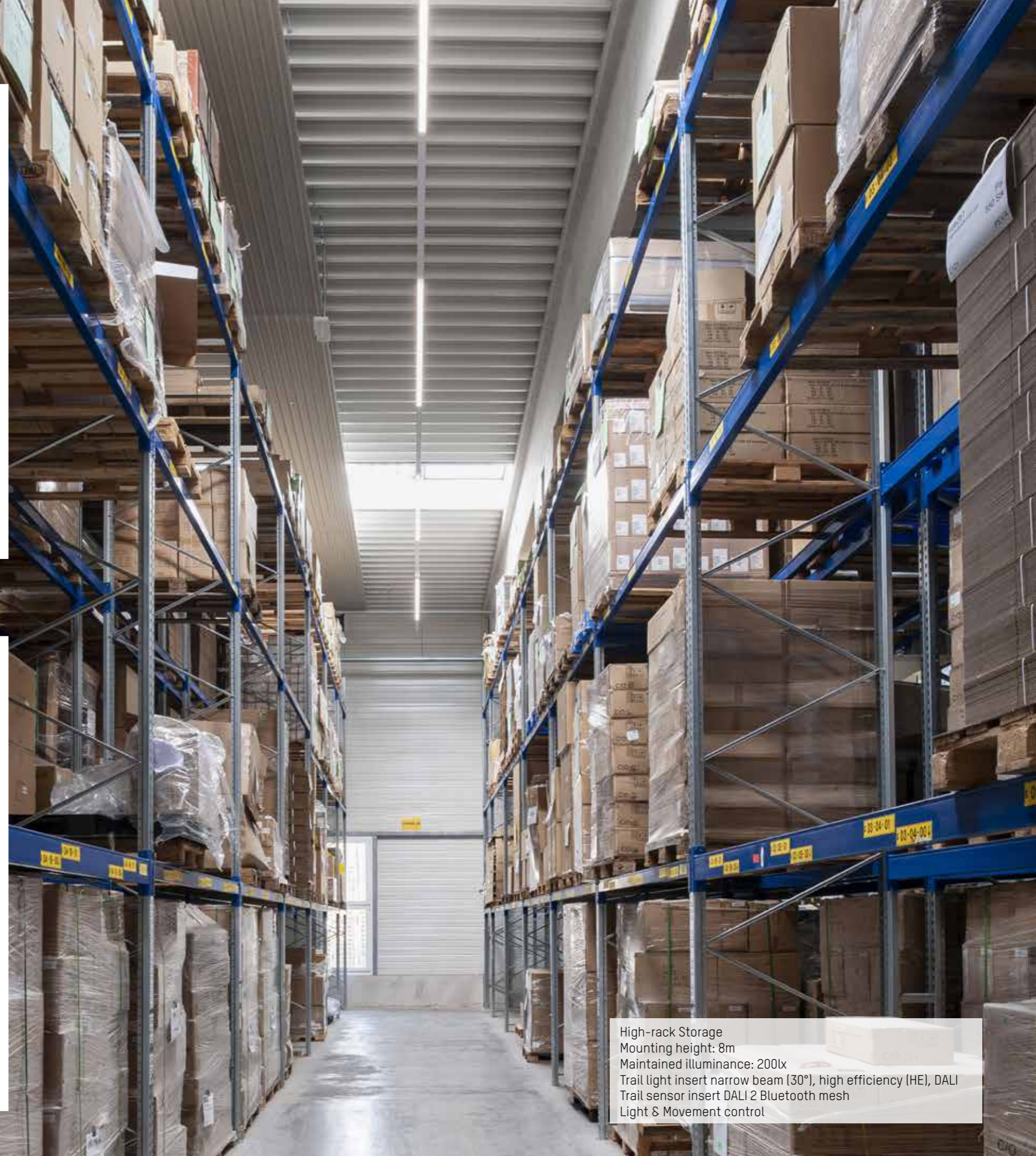
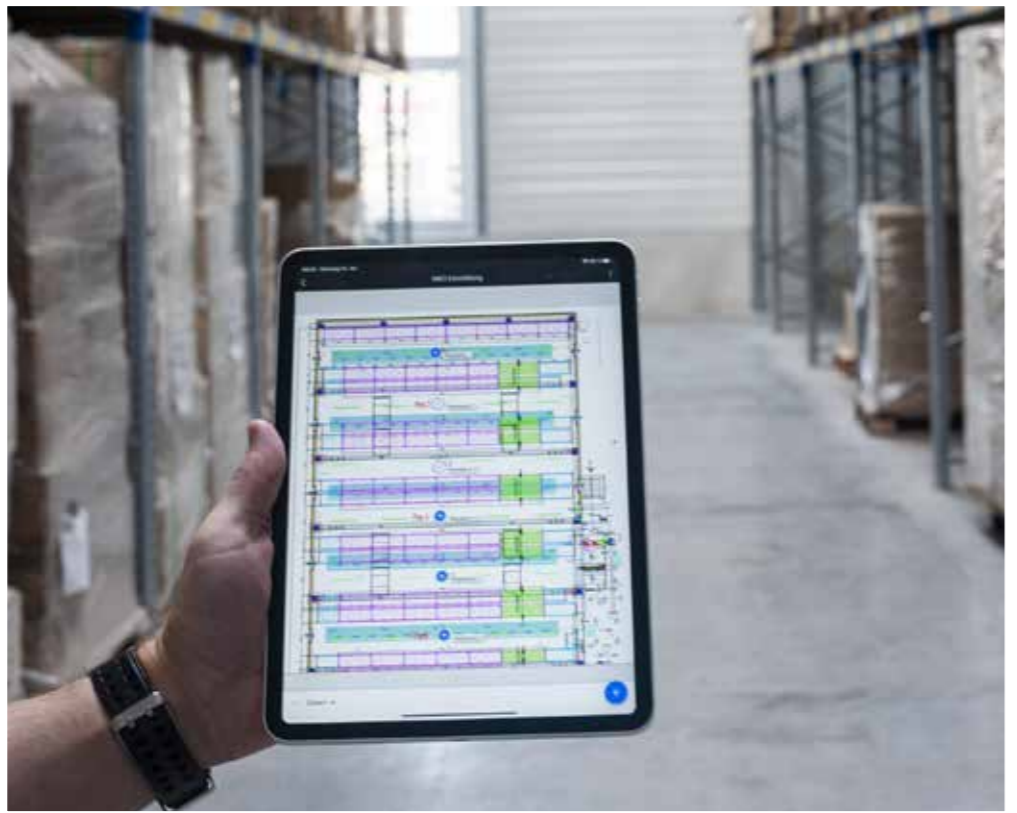

High-rack Storage  
Mounting height: 8m  
Maintained illuminance: 200lx  
Trail light insert narrow beam (30°), high efficiency (HE), DALI  
Trail sensor insert DALI 2 Bluetooth mesh  
Light & Movement control



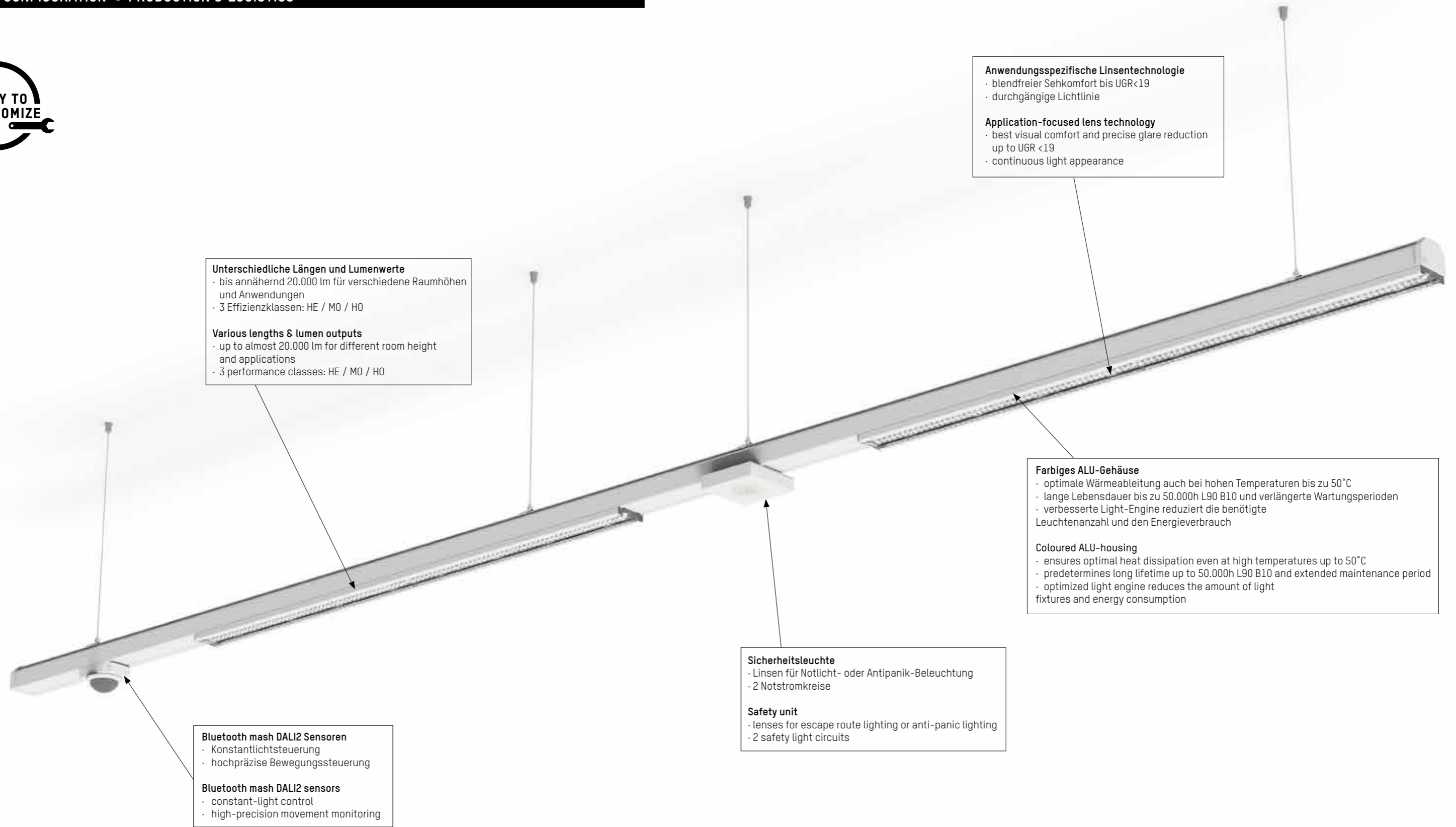

**Unterschiedliche Längen und Lumenwerte**  
 · bis annähernd 20.000 lm für verschiedene Raumhöhen und Anwendungen  
 · 3 Effizienzklassen: HE / MO / HO

**Various lengths & lumen outputs**  
 · up to almost 20.000 lm for different room height and applications  
 · 3 performance classes: HE / MO / HO

**Anwendungsspezifische Linsentechnologie**  
 · blendfreier Sehkomfort bis UGR<19  
 · durchgängige Lichtlinie

**Application-focused lens technology**  
 · best visual comfort and precise glare reduction up to UGR <19  
 · continuous light appearance

**Farbiges ALU-Gehäuse**  
 · optimale Wärmeableitung auch bei hohen Temperaturen bis zu 50°C  
 · lange Lebensdauer bis zu 50.000h L90 B10 und verlängerte Wartungsperioden  
 · verbesserte Light-Engine reduziert die benötigte Leuchtenanzahl und den Energieverbrauch

**Coloured ALU-housing**  
 · ensures optimal heat dissipation even at high temperatures up to 50°C  
 · predetermines long lifetime up to 50.000h L90 B10 and extended maintenance period  
 · optimized light engine reduces the amount of light fixtures and energy consumption

**Sicherheitsleuchte**  
 · Linsen für Notlicht- oder Antipanik-Beleuchtung  
 · 2 Notstromkreise

**Safety unit**  
 · lenses for escape route lighting or anti-panic lighting  
 · 2 safety light circuits

**Bluetooth mesh DALI2 Sensoren**  
 · Konstantlichtsteuerung  
 · hochpräzise Bewegungssteuerung

**Bluetooth mesh DALI2 sensors**  
 · constant-light control  
 · high-precision movement monitoring



MOLTO LUCE production hall 1711m<sup>2</sup>  
Mounting height: 5,4m  
Maintained illuminance: 750lx  
Trail light inserts wide beam (90°), mid output (M0), DALI  
Trail customised sensor IR Quattro HD - KNX, light & movement control

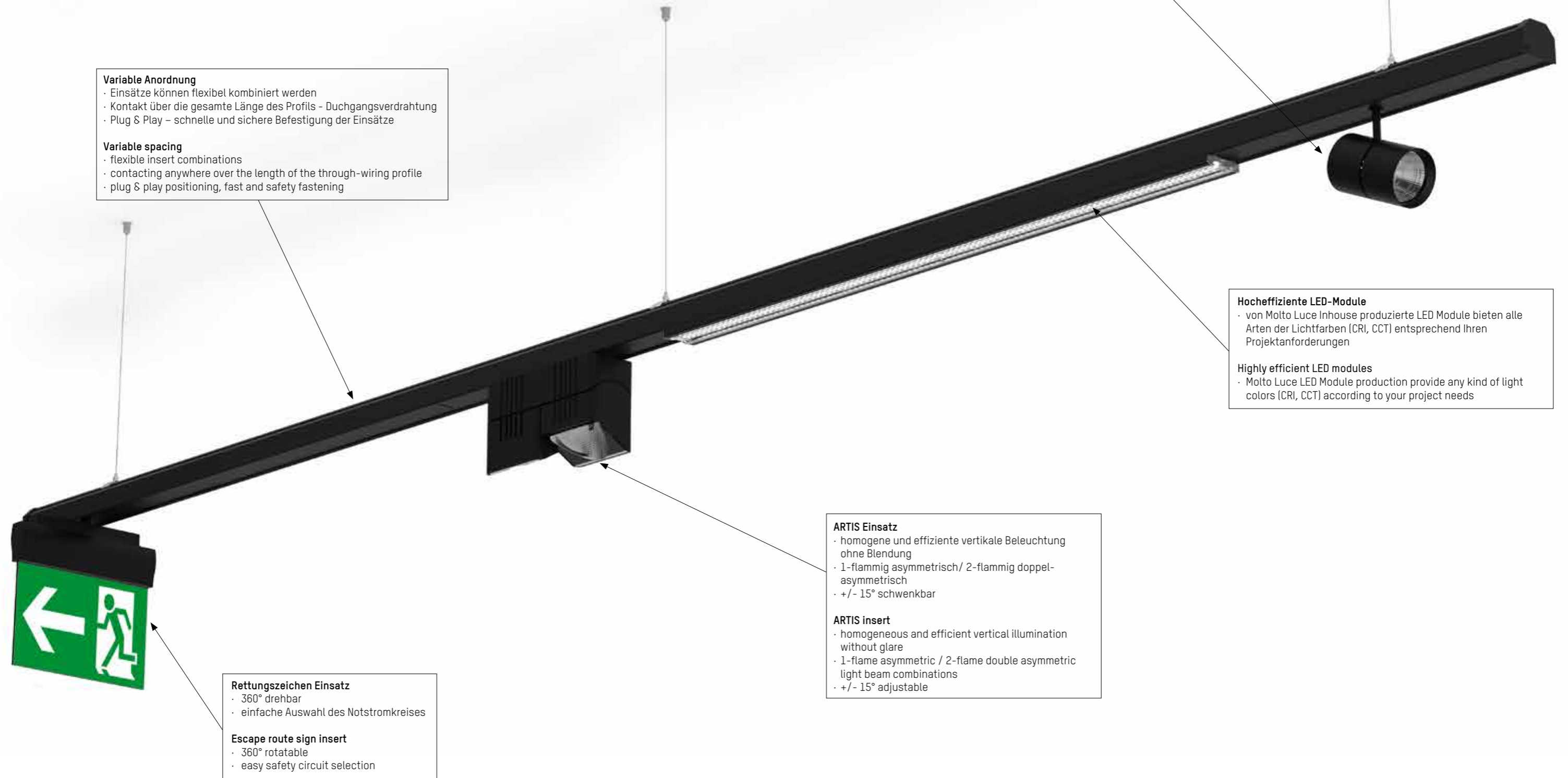

**Variable Anordnung**

- Einsätze können flexibel kombiniert werden
- Kontakt über die gesamte Länge des Profils - Durchgangsverdrahtung
- Plug & Play – schnelle und sichere Befestigung der Einsätze

**Variable spacing**

- flexible insert combinations
- contacting anywhere over the length of the through-wiring profile
- plug & play positioning, fast and safety fastening

**MOVA Einsatz**

- unzählige Möglichkeiten der Warenpräsentation
- wählbare Ausstrahlwinkel, CCTs, CRI, ECGs

**MOVA insert**

- many possibilities for the presentation of goods
- selectable beam angles, CCTs, CRI, ECGs

**Hocheffiziente LED-Module**

- von Molto Luce Inhouse produzierte LED Module bieten alle Arten der Lichtfarben (CRI, CCT) entsprechend Ihren Projektanforderungen

**Highly efficient LED modules**

- Molto Luce LED Module production provide any kind of light colors (CRI, CCT) according to your project needs

**ARTIS Einsatz**

- homogene und effiziente vertikale Beleuchtung ohne Blendung
- 1-flammig asymmetrisch/ 2-flammig doppel-asymmetrisch
- +/- 15° schwenkbar

**ARTIS insert**

- homogeneous and efficient vertical illumination without glare
- 1-flame asymmetric / 2-flame double asymmetric light beam combinations
- +/- 15° adjustable

**Rettungszeichen Einsatz**

- 360° drehbar
- einfache Auswahl des Notstromkreises

**Escape route sign insert**

- 360° rotatable
- easy safety circuit selection



FISCH/FLEISCH

Wir lieben  
Fleisch

Aus der  
Region

EUROGAST / Leibnitz / Austria  
Sales area, accent lighting  
Mounting height: 3,2m  
Trail Spot light insert

WIRING EXAMPLE → PRODUCTION & LOGISTICS

**Kombi 1 (7-polige Schiene)**  
ON/OFF & Notlicht

**Combi 1 (7-pole rail)**  
ON/OFF & safety

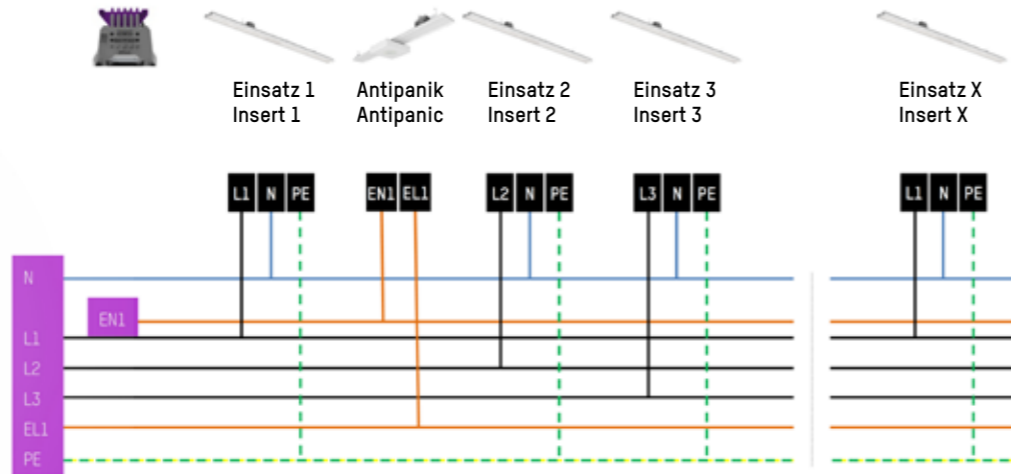
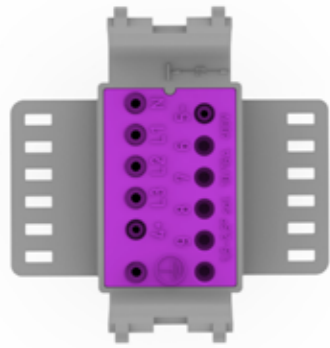

WIRING EXAMPLE → PRODUCTION & LOGISTICS

**Kombi 3 (11-polige Schiene)**  
DALI 2 Licht- & Bewegungssteuerung  
+ 2 Kreise für Sicherheitsbeleuchtung

**Combi 3 (11-pole rail)**  
DALI 2 light- & movement control  
+ 2 circles for safety lighting

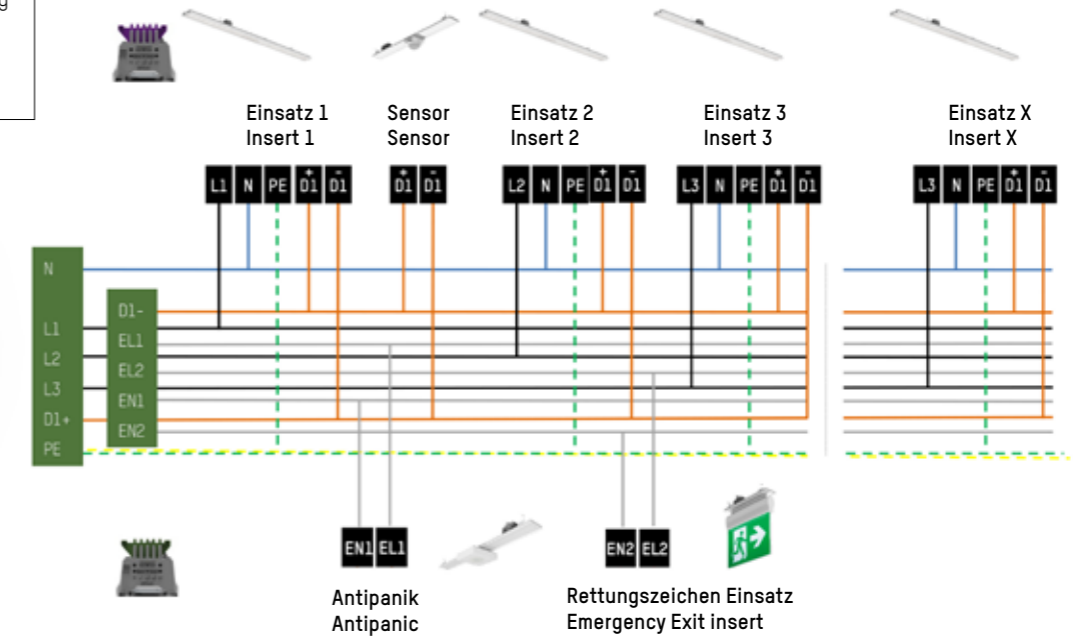
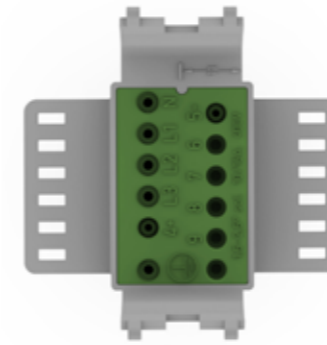

WIRING EXAMPLE → PRODUCTION & LOGISTICS

**Kombi 2 (7-polige Schiene)**  
DALI 2 Licht- & Bewegungssteuerung

**Combi 2 (7-pole rail)**  
DALI 2 light- & movement control

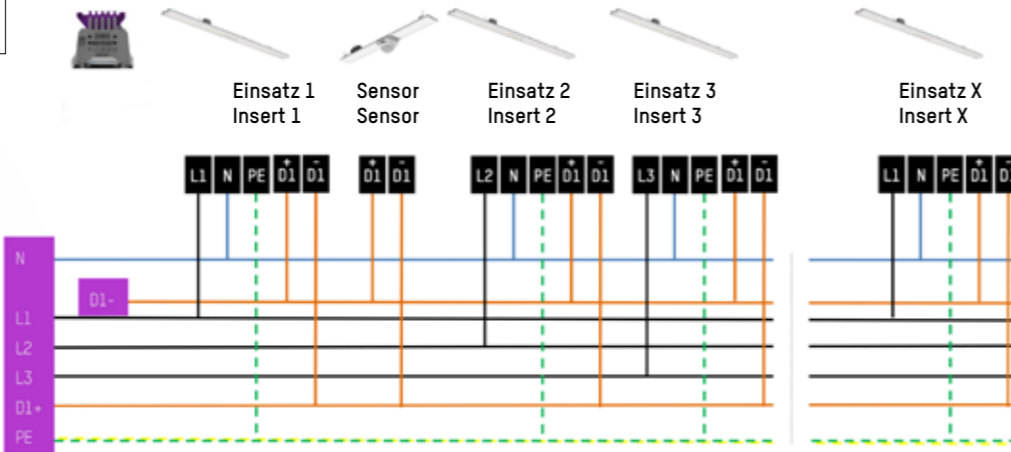
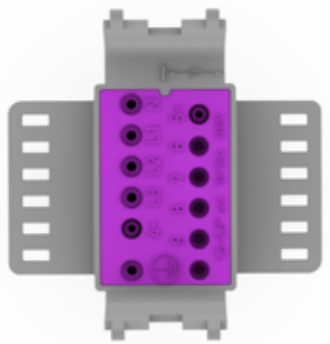

WIRING EXAMPLE → RETAIL

**Kombi 3 (11-polige Schiene)**  
L1 - ON / OFF Lichteinsätze  
L2 - MOVA  
L3 - ARTIS  
+ 2 Kreise für Sicherheitsbeleuchtung

**Combi 3 (11-pole rail)**  
L1 - ON / OFF light inserts  
L2 - MOVA  
L3 - ARTIS  
+ 2 circles for safety lighting

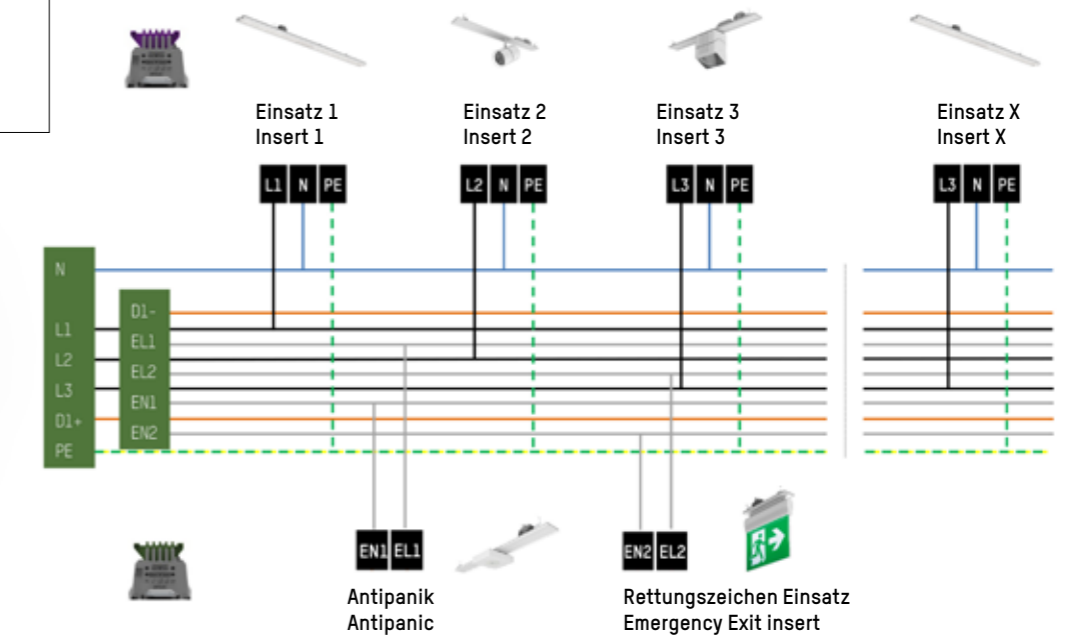
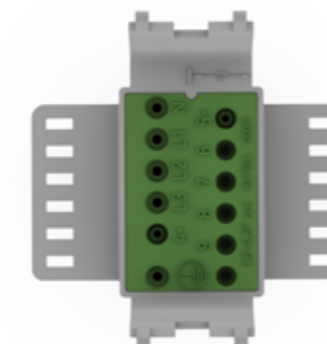

TRAIL MOUNTING EXAMPLES

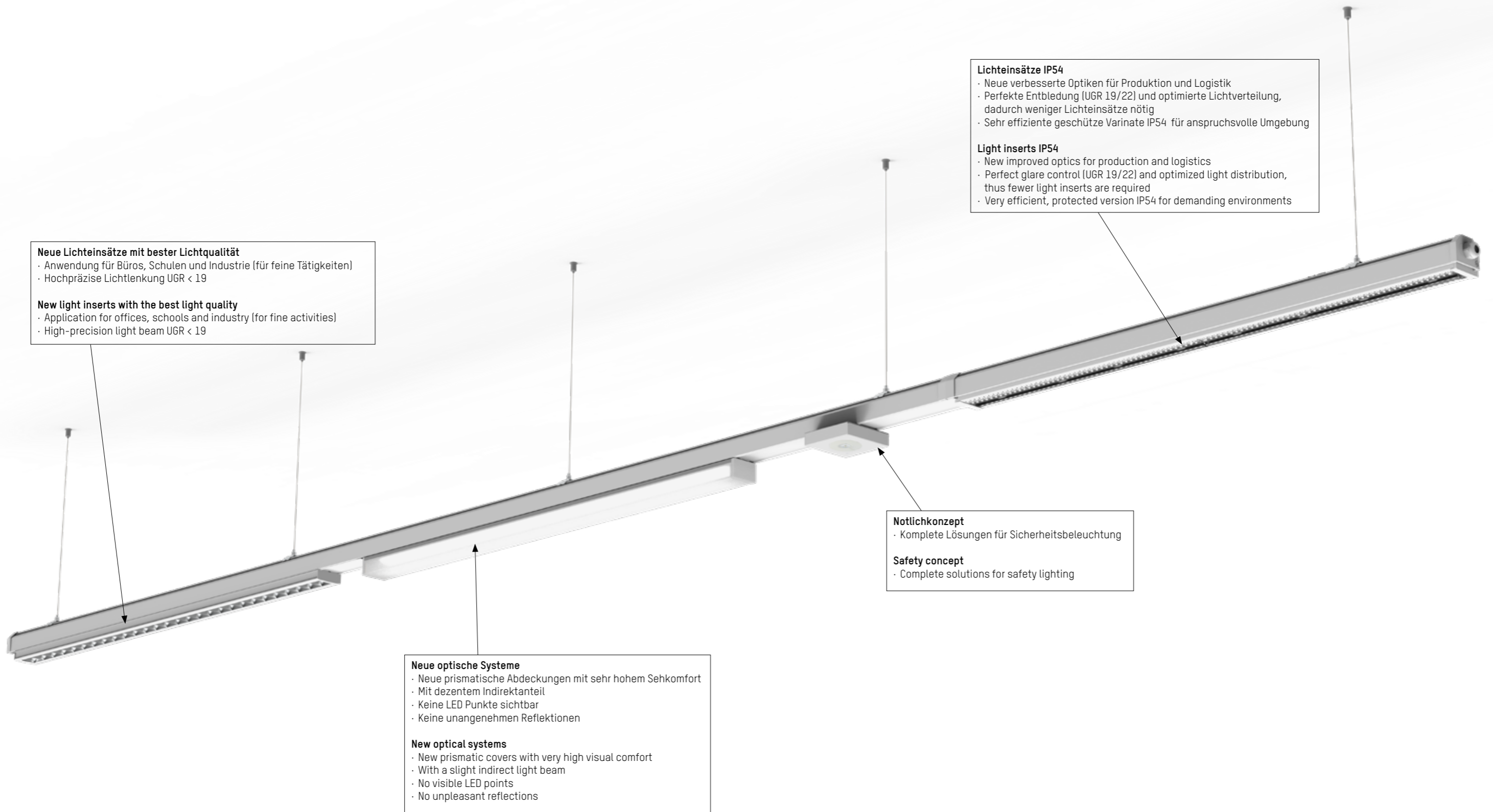

**Neue Lichteinsätze mit bester Lichtqualität**  
 · Anwendung für Büros, Schulen und Industrie (für feine Tätigkeiten)  
 · Hochpräzise Lichtlenkung UGR < 19

**New light inserts with the best light quality**  
 · Application for offices, schools and industry (for fine activities)  
 · High-precision light beam UGR < 19

**Lichteinsätze IP54**  
 · Neue verbesserte Optiken für Produktion und Logistik  
 · Perfekte Entblendung (UGR 19/22) und optimierte Lichtverteilung, dadurch weniger Lichteinsätze nötig  
 · Sehr effiziente geschützte Variante IP54 für anspruchsvolle Umgebung

**Light inserts IP54**  
 · New improved optics for production and logistics  
 · Perfect glare control (UGR 19/22) and optimized light distribution, thus fewer light inserts are required  
 · Very efficient, protected version IP54 for demanding environments

**Notlichkonzept**  
 · Komplexe Lösungen für Sicherheitsbeleuchtung

**Safety concept**  
 · Complete solutions for safety lighting

**Neue optische Systeme**  
 · Neue prismatische Abdeckungen mit sehr hohem Sehkomfort  
 · Mit dezentem Indirektanteil  
 · Keine LED Punkte sichtbar  
 · Keine unangenehmen Reflektionen

**New optical systems**  
 · New prismatic covers with very high visual comfort  
 · With a slight indirect light beam  
 · No visible LED points  
 · No unpleasant reflections