



BE-LIGHTING CONCEPT N.V. - S.A.
GEMEENTESTRAAT 44 - RUE COMMUNALE 44
1083 GANSHOREN (BRUSSELS - BELGIUM)
TÉL: +32 (0)2 421 09 70
FAX: +32 (0)2 426 17 90
MAIL: INFO@BE-LIGHTINGCONCEPT.BE
WEB: WWW.BE-LIGHTINGCONCEPT.BE

MOLTO LUCE®

3

W

D

I

R

PENDELLEUCHTEN / PENDANTS

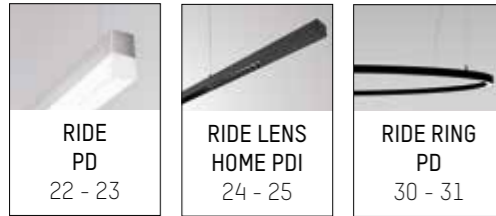

RIDE PD
22 - 23

RIDE LENS HOME PDI
24 - 25

RIDE RING PD
30 - 31

AUFBAULEUCHTEN / SURFACE LUMINAIRES



RIDE BLIND SD
20 - 21

RIDE SD
18 - 19

RIDE RING SD
28 - 29

EINBAULEUCHTEN / RECESSED LUMINAIRES

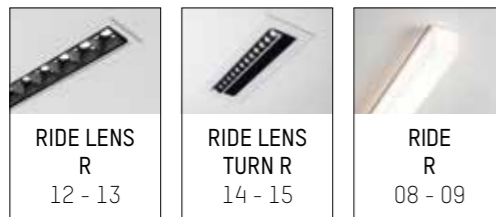

RIDE LENS R
12 - 13

RIDE LENS TURN R
14 - 15

RIDE R
08 - 09

PROFILSYSTEME / PROFILE SYSTEMS

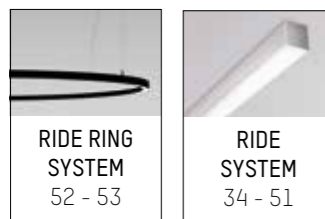

RIDE RING SYSTEM
52 - 53

RIDE SYSTEM
34 - 51

AUSSENLEUCHTEN / OUTDOOR LUMINAIRES



RIDE IP54 R
54 - 55

RIDE IP54 SD
56 - 57

W	weiß	white	bianco	blanc
S	silber	silver	argento	argent
AE	aluminium eloxiert	aluminium anodized	alluminio anodizzato	aluminium anodisé
S	schwarz	black	nero	noir
SE	schwarz gebürstet eloxiert	black brushed anodized	nero grafite spazzolato anodizzato	noir brossé anodisé
W2	LED 2700K	LED 2700K	LED 2700K	LED 2700K
W3	LED 3000K	LED 3000K	LED 3000K	LED 3000K
W4	LED 4000K	LED 4000K	LED 4000K	LED 4000K
S	schaltbar	switchable	commutabile	commutable
D	DALI dimm	DALI dimm	DALI dimm	DALI dimm
20°	Ausstrahlwinkel	Beam angle	Angolo di radiazione	Angle de rayonnement
↻	dreh- und schwenkbar	twistable and pivoting	orientabile e girevole	orientable et pivotant
↻	drehbar	twistable	girevole	pivotant
↻	schwenkbar	pivoting	orientabile	orientable
▨	Deckenstärke	ceiling thickness	spessore soffitto	épaisseur du plafond
ET	Einbautiefe	recessed depth	profondità di montaggio	hauteur de montage
⊖	Deckenausschnitt rund	ceiling cutout round	soffitto ritaglio rotondo	Découpe de plafond ronde
⊖	Deckenausschnitt quadratisch	ceiling cutout square	soffitto ritaglio quadrata	Découpe de plafond quadratico
PMMA	PMMA Opaldiffuser flach	PMMA opal diffuser flat	PMMA diffusore opale piatto	PMMA diffuseur opale plat
PMMA	PMMA Opaldiffuser kubisch	PMMA opal diffuser cubic	PMMA diffusore opale cubo	PMMA diffuseur opale cubique
PMMA	Microprismatischer Diffuser flach	Microprismatic diffuser flat	Microprismatica diffusore piatto	Microprismatique diffuseur plat

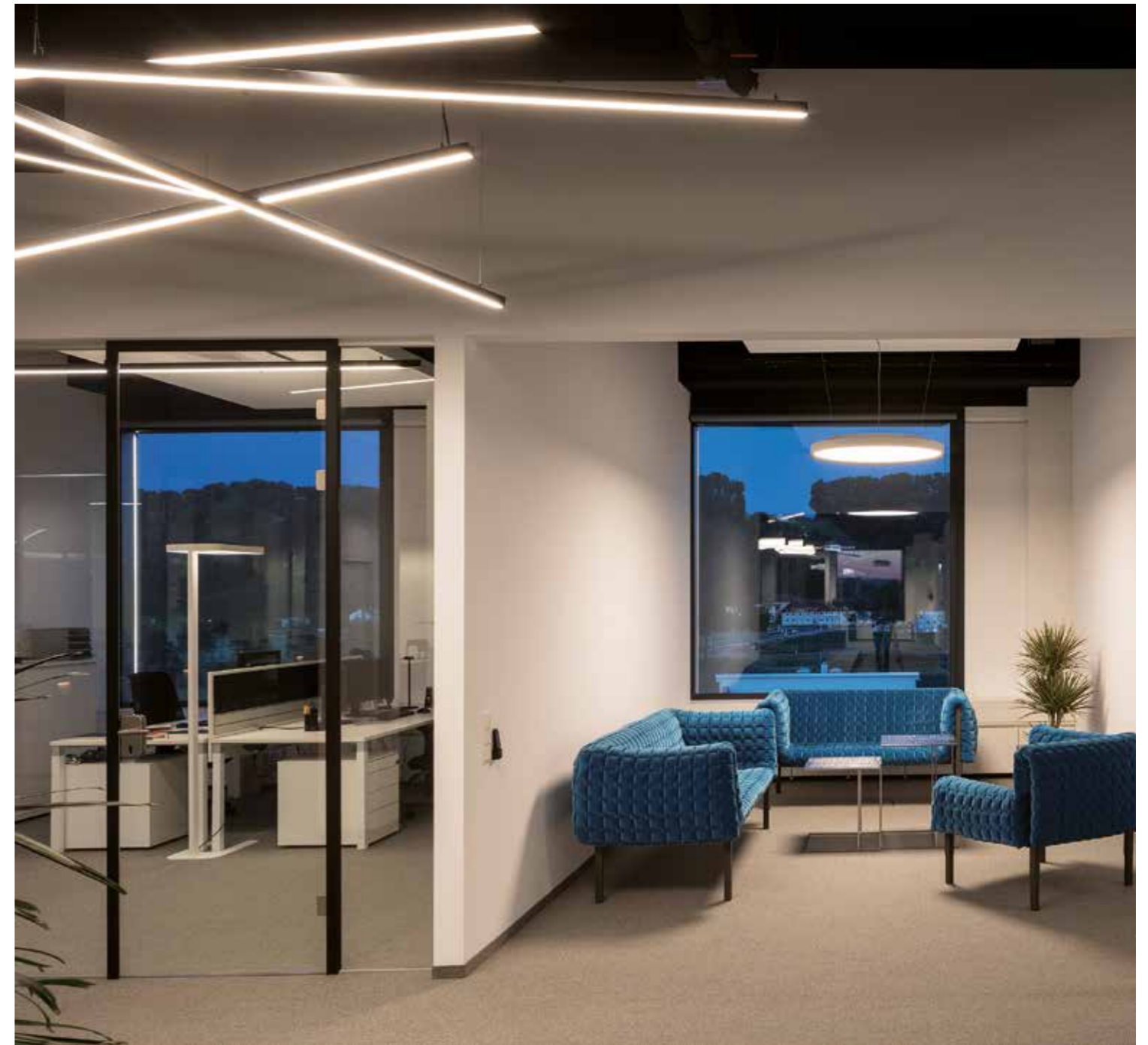

LED DRIVER INSIDE

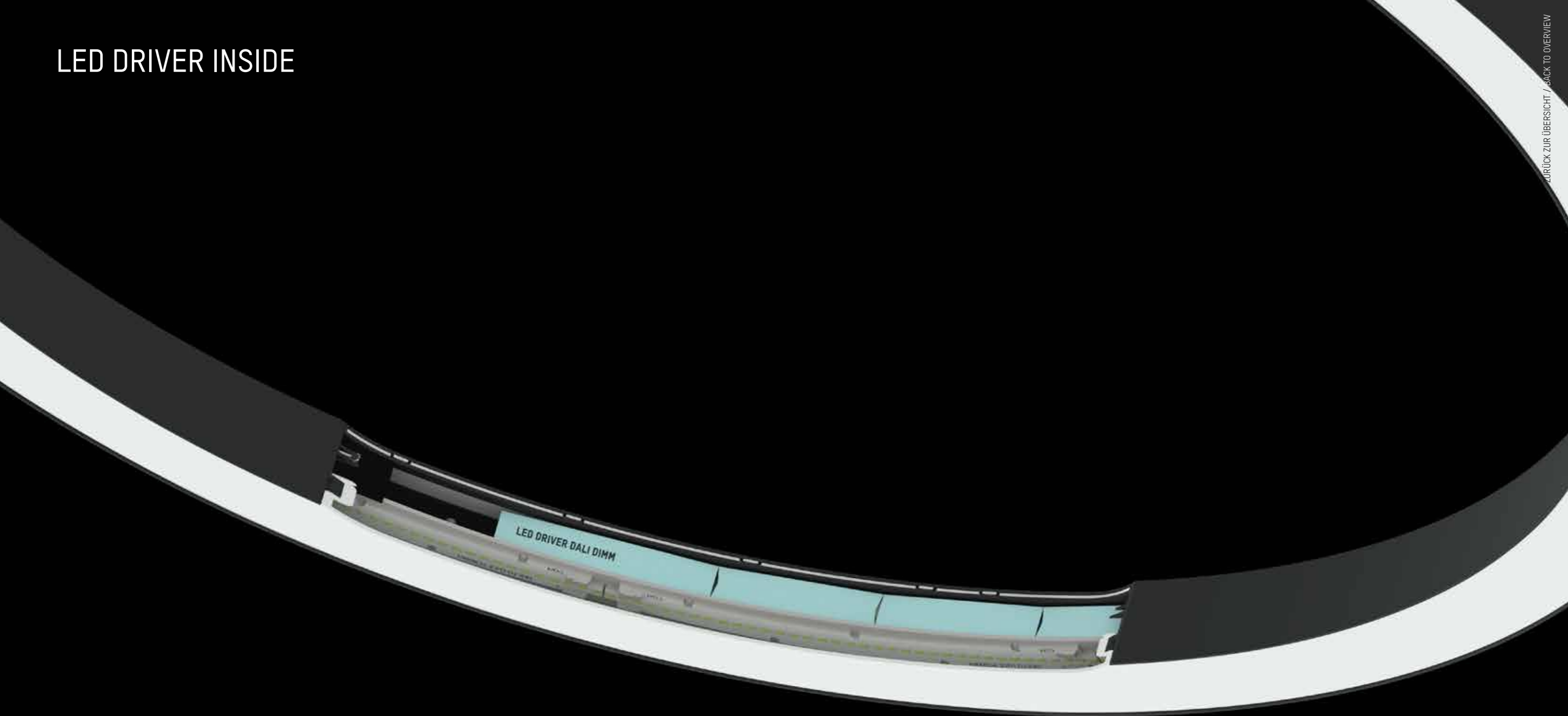

ZURÜCK ZUR ÜBERSICHT / BACK TO OVERVIEW

Das Ride System mit nur 35x35mm, behält auch durch den im Profil verbauten Konverter seine minimalistische Form und schafft einen auf das Nötigste reduzierten Baldachin. Ride Ring vereint durch seinen gebogenen Konverter die optischen Highlights und ist eine gelungene Erweiterung. Technisch ist der in beiden Variationen erhältliche Konverter auch in Dali dimmbar verfügbar und ermöglicht zusätzlich eine stimmige Lichtwirkung. Ein bis ins kleinste Detail durdachtes System.

The Ride system, just 35x35mm in size, maintains its minimalistic shape even with the driver built into the profile and creates a canopy reduced to the bare essentials. With its curved converter, Ride Ring unifies the optical highlights and is an accomplished extension. Technically speaking, the converter available in both variants is also available in Dali dimmable and additionally permits a harmonious lighting effect. A system which has been thought through down to the smallest detail.



WIDE RANGE OF LIGHT AND SHAPES

Ride ist mit einem Querschnitt von nur 35x35mm eines der schlanksten LED-Lichtbandsysteme, die auf dem Markt angeboten werden. Das Besondere: Ride stellt aufgrund eines im System integrierten Konverters auch bei Längen von bis zu 15m einen durchgängigen Lichtaustritt sicher. Zudem gewährleisten bei Anwendungen mit Eckmontage auch die eingesetzten Winkelverbindungen eine gleichmäßige Lichtverteilung. Ride ist eine edle Lichtlösung, gefertigt aus einem stranggepresstem Aluminiumprofil in den Oberflächen Aluminium eloxiert sowie Weiß oder Schwarz pulverbeschichtet. Ride bringt eine enorme Varianten-Vielfalt mit sich, die unterschiedliche Erfordernisse bestens abdecken kann. Ob als Einbau-, Decken-, Wand-, oder Pendelleuchte ist Ride sowohl als Einzel- als auch Systemleuchte verfügbar. Varianten mit flacher oder kubischer Opalabdeckung, wahlweise auch mit Mikroprismenabdeckung, machen vor keiner Aufgabe halt. In der Deckeneinbau- und Deckenaufbauvariante ist Ride zusätzlich als IP54-Lösung erhältlich. Auch im System bietet Ride mit zahlreichen Lichteinsätzen eine Vielzahl an Möglichkeiten. Mit Ride Lens als Deckeneinbau- oder Pendelleuchte wurde die Produktfamilie um eine weitere perfekt entblendete Variante mit $UGR < 16$ erweitert. Erreicht wird dies mittels eines schwarzen Hochglanzrasters in Kombination mit zurückversetzten, speziell abgestimmten Linsen.

With a cross-section of just 35x35mm, Ride is one of the slimmest linear LED profile systems on the market. Due to an integrated converter, Ride can guarantee continuous light emission along lengths of up to 15m. The angled fittings used in corner-mounted applications also guarantee even light distribution. Ride is an exquisite pressure-diecast aluminium lighting solution and available in anodised aluminium, black or white finishes. The Ride series encompasses a huge variety of variants which can perfectly cover widely varying requirements. Ride is also available as a single recessed ceiling, wall or pendant system light. Variants with a flat, cubic or microprism cover know no limitations in use. Ride is additionally available as an IP54 solution in flush-fitting and surface-mounted ceiling variants. With numerous lighting inserts, Ride also offers a great number of options as a lighting system. With Ride Lens as a flush-fitting or pendant ceiling light, a further perfectly glare-suppressed variant has been added to the product family. This is achieved by means of a black high-gloss screen with recessed, specially aligned lenses.

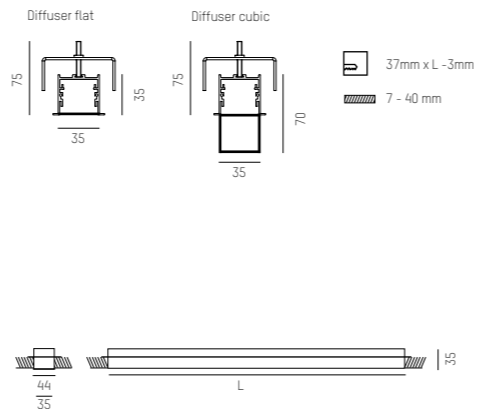

RIDE R

220-240V AC/DC · CRI >90 · Binning SDCM 3

SYS 10W (nicht dimmbar/not dimmable)

1:	W2 = 820lm	W3 = 890lm	W4 = 930lm
2:	W2 = 920lm	W3 = 1010lm	W4 = 1050lm
3:	W2 = 780lm	W3 = 850lm	W4 = 880lm

577-01101C023XX0	W2	L: 581mm
577-01101C029XX0	W3	L: 581mm
577-01101C024XX0	W4	L: 581mm

SYS 15W

1:	W2 = 1230lm	W3 = 1340lm	W4 = 1400lm
2:	W2 = 1390lm	W3 = 1510lm	W4 = 1570lm
3:	W2 = 1170lm	W3 = 1270lm	W4 = 1320lm

577-01102C023XXY	W2	L: 861mm
577-01102C029XXY	W3	L: 861mm
577-01102C024XXY	W4	L: 861mm

SYS 19W

1:	W2 = 1650lm	W3 = 1790lm	W4 = 1860lm
2:	W2 = 1850lm	W3 = 2020lm	W4 = 2100lm
3:	W2 = 1560lm	W3 = 1700lm	W4 = 1770lm

577-01103C023XXY	W2	L: 1141mm
577-01103C029XXY	W3	L: 1141mm
577-01103C024XXY	W4	L: 1141mm

SYS 24W

1:	W2 = 2060lm	W3 = 2240lm	W4 = 2330lm
2:	W2 = 2320lm	W3 = 2520lm	W4 = 2620lm
3:	W2 = 1950lm	W3 = 2120lm	W4 = 2210lm

577-01104C023XXY	W2	L: 1421mm
577-01104C029XXY	W3	L: 1421mm
577-01104C024XXY	W4	L: 1421mm

SYS 48W

1:	W2 = 4130lm	W3 = 4490lm	W4 = 4670lm
2:	W2 = 4640lm	W3 = 5050lm	W4 = 5250lm
3:	W2 = 3910lm	W3 = 4250lm	W4 = 4420lm

577-01105C023XXY	W2	L: 2821mm
577-01105C029XXY	W3	L: 2821mm
577-01105C024XXY	W4	L: 2821mm

SYS 71W

1:	W2 = 6190lm	W3 = 6730lm	W4 = 7000lm
2:	W2 = 6970lm	W3 = 7570lm	W4 = 7870lm
3:	W2 = 5870lm	W3 = 6380lm	W4 = 6640lm

577-01106C023XXY	W2	L: 4221mm
577-01106C029XXY	W3	L: 4221mm
577-01106C024XXY	W4	L: 4221mm

LED Lichtprofil aus stranggepresstem Aluminium
Oberfläche eloxiert, schwarz oder weiß pulverbeschichtet
LED Konverter im Leuchtenprofil integriert
Geeignet für den Einbau in Zwischendecken von 7-40mm
Flache oder vorspringende kubische Abdeckung

LED profile, extruded aluminium
Anodised surface, white or black powder-coated
Built-in LED converter in profile
For false ceiling 7-40mm thickness
Flat or cubic diffuser

Profilo in alluminio pressofuso a LED
Finitura anodizzata, verniciatura a polveri bianca o nero
Converter LED integrato nel profilo
Idonea per controsoffitti di spessore 7-40mm
Diffusore piatto o cubico

Profil en Led en aluminium extrudé
Finition anodisée ou laquée blanc ou noir
Convertisseur intégré dans le profil
Pour faux-plafond 7-40mm d'épaisseur
diffuseur plat ou cubique

W2 = LED 2700K
W3 = LED 3000K
W4 = LED 4000K

A++ - A

IP20 CE

ARTIKELNUMMER ERGÄNZEN / COMPLETE CODE

C = ABDECKUNG / COVER

XX = FARBE / COLOUR

Y = DIMMBAR / DIMMABLE

PMMA opal diffuser flat = 1

W white = 05

S switchable = 0

PMMA opal diffuser cubic = 2

S black = 06

D DALI dimm = d

Microprismatic cover flat = 3

AE aluminium anodized = 08





Project: Hotel am Konzerthaus | Vienna | Austria



Project: Private residence | Austria



Project: F. List Franz staff restaurant | Thomasberg | Austria

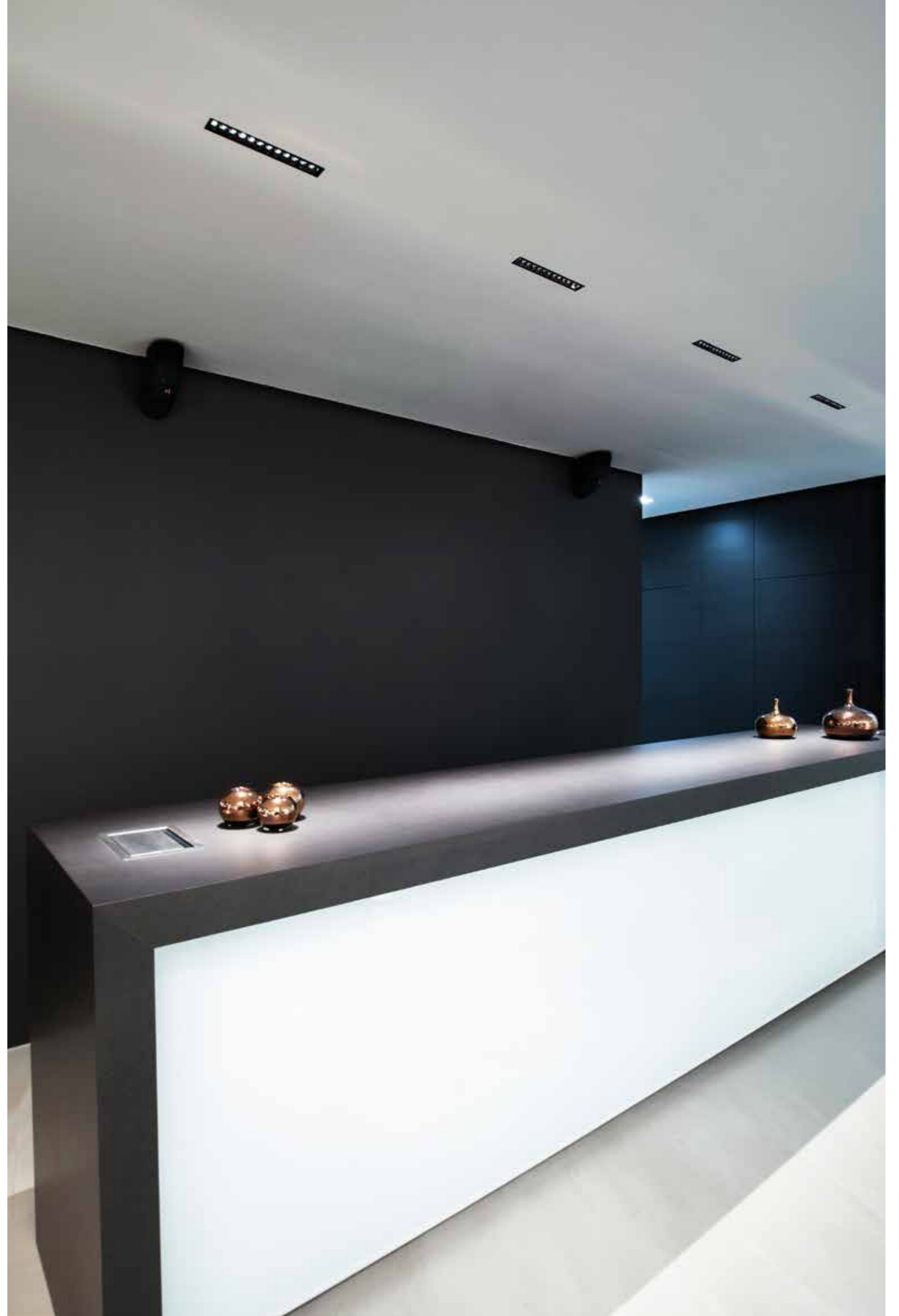

Project: MOLTO LUCE | Munich | Germany

ZURÜCK ZUR ÜBERSICHT / BACK TO OVERVIEW

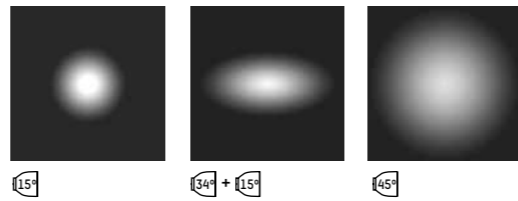
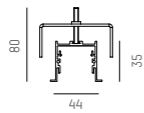
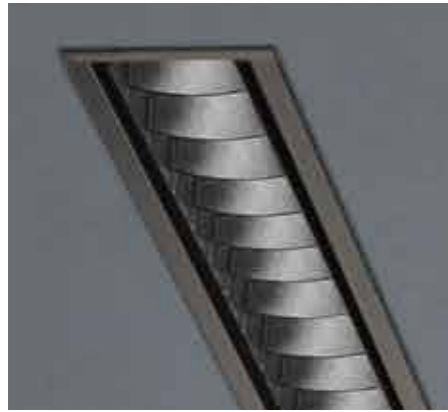

RIDE LENS R

CRI >90 · Binning SDCM 3

exkl. LED Konverter (separat ordern) / excl. LED converter (order separately)

LED 6W · 500mA

634-002040123XX	W2	15°	460lm
634-002040129XX	W3	15°	510lm
634-002040124XX	W4	15°	550lm

634-002040623XX	W2	34° + 15°	440lm
634-002040629XX	W3	34° + 15°	480lm
634-002040624XX	W4	34° + 15°	520lm

634-002040323XX	W2	45°	460lm
634-002040329XX	W3	45°	510lm
634-002040324XX	W4	45°	550lm

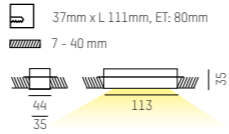

LED KONVERTER / LED CONVERTER

24-122201	500mA, not dimmable	1-2 RIDE 6W
24-123403	500mA, DALI dimm.	1-2 RIDE 6W

LED 17W · 500mA

634-002010123XX	W2	15°	1400lm
634-002010129XX	W3	15°	1530lm
634-002010124XX	W4	15°	1650lm

634-002010623XX	W2	34° + 15°	1330lm
634-002010629XX	W3	34° + 15°	1450lm
634-002010624XX	W4	34° + 15°	1560lm

634-002010323XX	W2	45°	1400lm
634-002010329XX	W3	45°	1530lm
634-002010324XX	W4	45°	1650lm

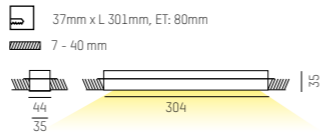

LED KONVERTER / LED CONVERTER

24-122201	500mA, not dimmable	1 RIDE 17W
24-123403	500mA, DALI dimm.	1 RIDE 17W

Schmale LED Einbauleuchte
Oberfläche eloxiert, weiß oder schwarz pulverbeschichtet
Zurückversetzte Linsen mit verschiedenen Abstrahlwinkeln
Perfekte Entblendung durch schwarzen Hochglanzraster

Slim LED recessed luminaire
Anodised surface, black or white powder-coated
Recessed lense with different beam angles
Perfect anti-glare due to black high-gloss grid

Incasso LED a ridotto ingombro
Finitura anodizzata, verniciatura a polveri bianca o nero
Lente retrocessa con differenti fasci di emissione
Griglia nera lucida per controllo anti-abbagliamento

Encastré fin à LED
Anodisé ou vernissé à poudre en blanc ou noir
Optique placée en fond combiné avec darklight
Contrôle anti-éblouissement optique darklight

UGR <19

W2 = LED 2700K
W3 = LED 3000K
W4 = LED 4000K

A+ - A

IP 20

ARTIKELNUMMER ERGÄNZEN / COMPLETE CODE

XX = FARBE/COLOUR

W white = 05
S black = 06
AE aluminium anodized = 08

LED 31W · 900mA

634-002020123XX	W2	15°	2560lm
634-002020129XX	W3	15°	2780lm
634-002020124XX	W4	15°	3000lm

634-002020623XX	W2	34° + 15°	2420lm
634-002020629XX	W3	34° + 15°	2630lm
634-002020624XX	W4	34° + 15°	2840lm

634-002020323XX	W2	45°	2560lm
634-002020329XX	W3	45°	2780lm
634-002020324XX	W4	45°	3000lm

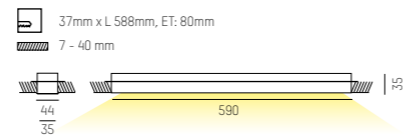

LED KONVERTER / LED CONVERTER

24-122204	900mA, not dimmable	1 RIDE 30W
24-15141350	900mA, DALI dimm.	1 RIDE 30W

LED 47W · 1400mA

634-002030123XX	W2	15°	3840lm
634-002030129XX	W3	15°	4170lm
634-002030124XX	W4	15°	4510lm

634-002030623XX	W2	34° + 15°	3630lm
634-002030629XX	W3	34° + 15°	3950lm
634-002030624XX	W4	34° + 15°	4270lm

634-002030323XX	W2	45°	3840lm
634-002030329XX	W3	45°	4170lm
634-002030324XX	W4	45°	4510lm

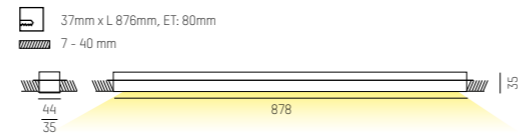

LED KONVERTER / LED CONVERTER

24-1222084	1400mA, not dimmable	1 RIDE 47W
24-123170	1400mA, DALI dimm.	1 RIDE 47W

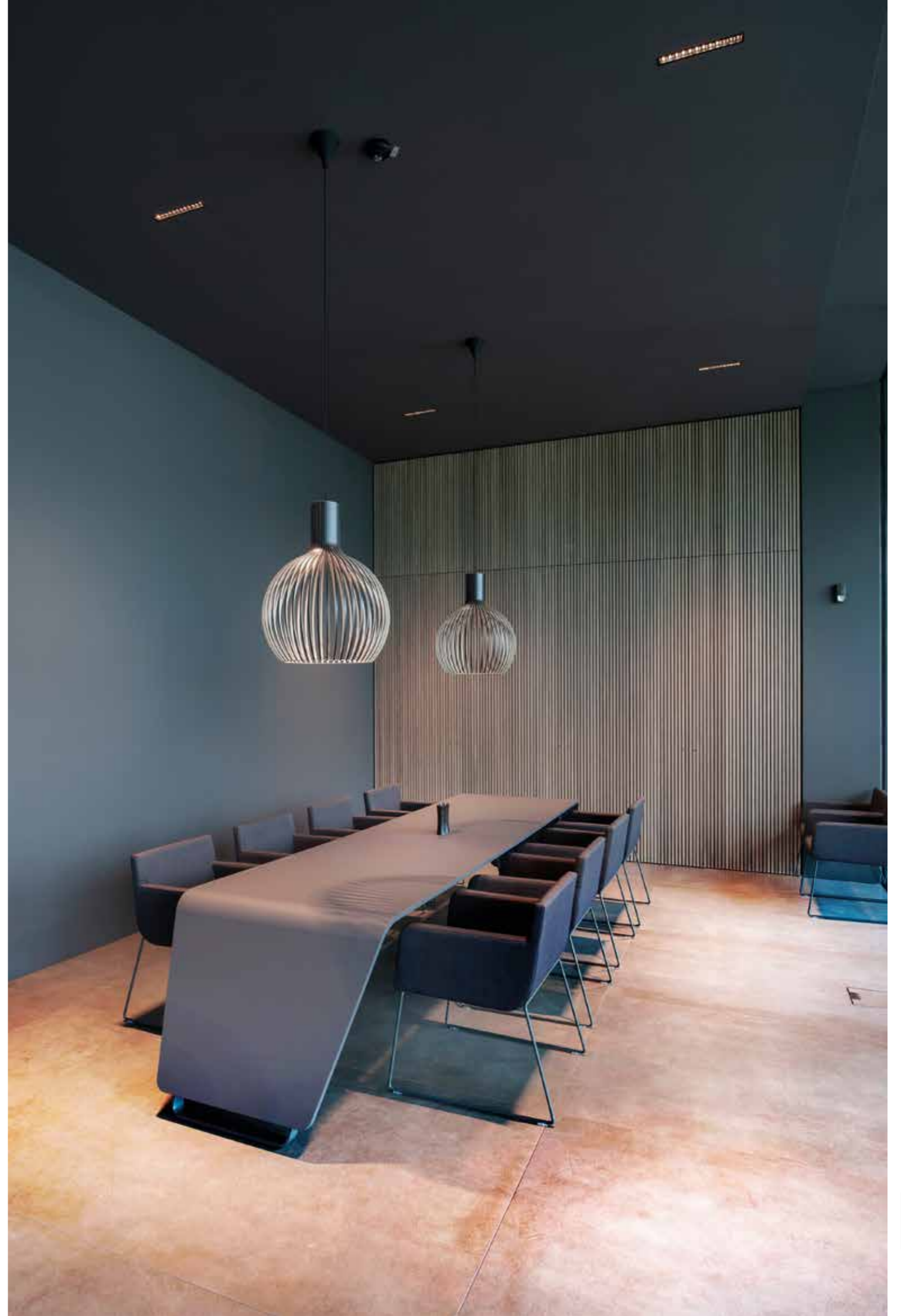

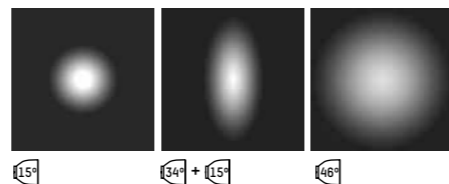
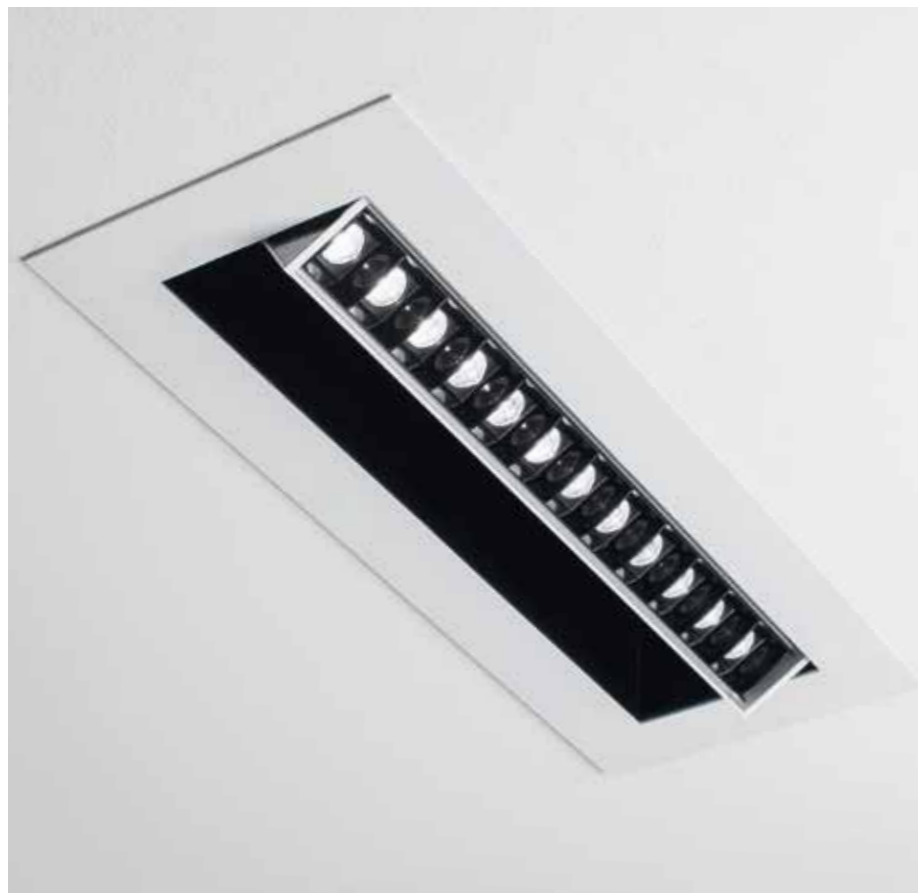

LED Einbauleuchte schwenkbar

Oberfläche eloxiert, weiß oder schwarz pulverbeschichtet
Zurückversetzte Linsen mit verschiedenen Abstrahlwinkeln
Perfekte Entblendung durch schwarzen Hochglanzraster
Energieeffiziente LEDs mit hoher Farbwiedergabe

LED tilting recessed luminaire

Anodised surface, black or white powder-coated
Recessed lense with different beam angles
Perfect anti-glare due to black high-gloss grid
High colour rendering energy efficient LED

Incasso LED in alluminio

Anodizzato, a polveri in bianco o nero
Lenti retrocesse con differenti vincoli ottiche
Antiabbagliamento totale dovuto alla griglia nera
Elevata resa cromatica, LED ad alta efficienza energetica

Encassé à LED en aluminium

Surface peinture en poudre anodisée, blanche ou noire
Lentille encastrée avec différents faisceaux
Antireflet parfait grâce à la grille haute brillance noire
Efficientes LED à haute reproduction des couleurs

UGR < 19

W2 = LED 2700K
W3 = LED 3000K
W4 = LED 4000K

A+ - A

IP20 CE

RIDE LENS TURN R

CRI >90 · Binning SDCM 3

exkl. LED Konverter (separat ordern) / excl. LED converter (order separately)

LED 17W · 500mA

634-007010123XX W2 15° 1400lm
634-007010129XX W3 15° 1530lm
634-007010124XX W4 15° 1650lm

634-007010623XX W2 34° + 15° 1330lm
634-007010629XX W3 34° + 15° 1450lm
634-007010624XX W4 34° + 15° 1560lm

634-007010323XX W2 45° 1400lm
634-007010329XX W3 45° 1530lm
634-007010324XX W4 45° 1650lm

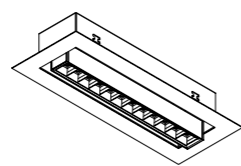
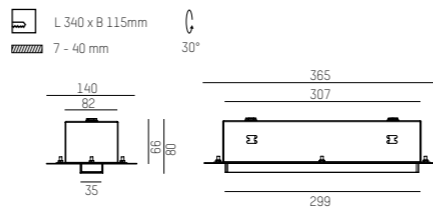

LED-KONVERTER / LED CONVERTER

24-122201 500mA, not dimmable 1 RIDE 17W
24-123403 500mA, DALI dimm. 1 RIDE 17W

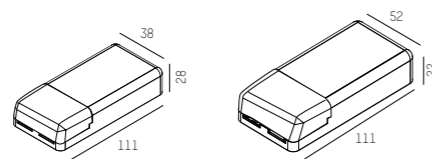

ARTIKELNUMMER ERGÄNZEN / COMPLETE CODE

XX = FARBE/COLOUR

W white = 05
S black = 06





RIDE LENS · 17W · 2700K · 1400lm
spot light beam 15°



RIDE LENS · 17W · 2700K · 1400lm
medium light beam 45°



RIDE LENS · 17W · 2700K · 1330lm
oval light beam $34^\circ + 15^\circ$

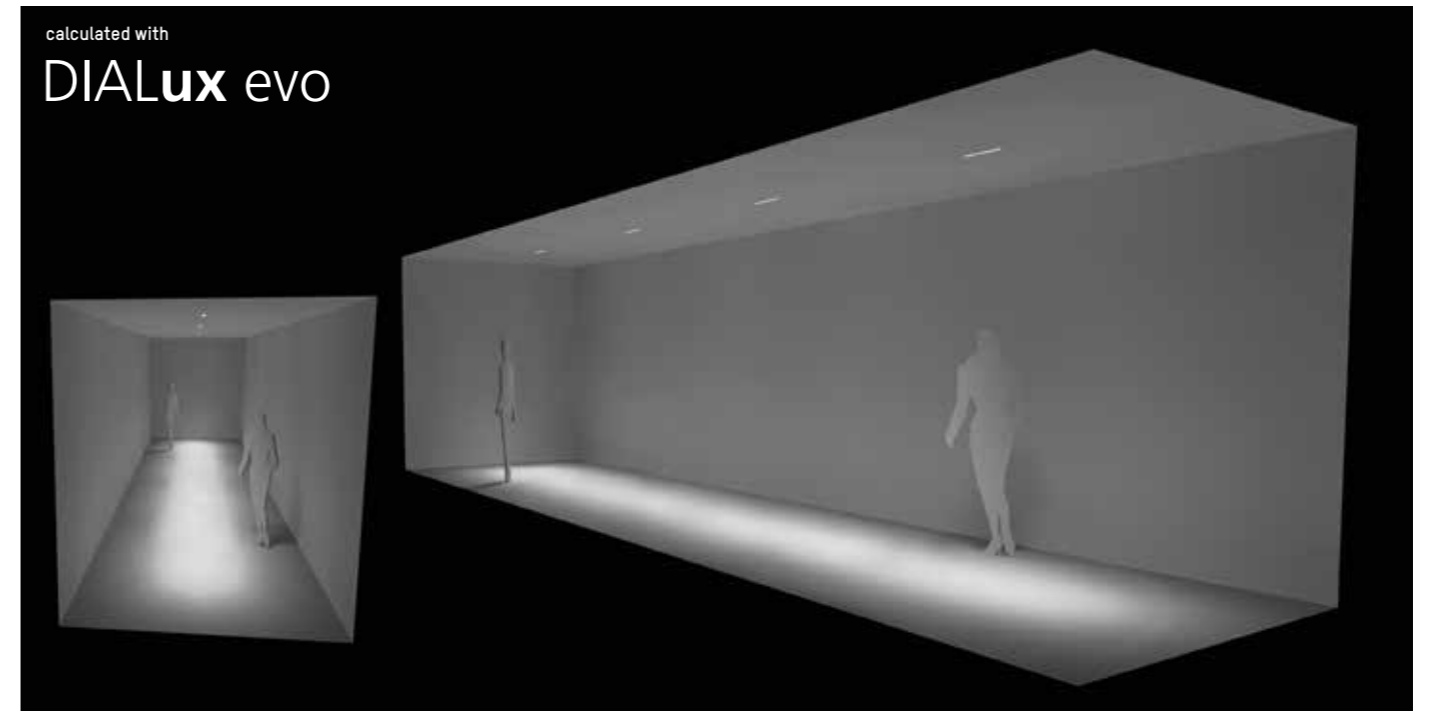

Used products:

4 x RIDE recessed 17W oval $34^\circ + 15^\circ$
 Roomsize: L 10m x W 2,5m x H 2,8m
 Distance luminaire-luminaire: 2,2m
 Em: 380lx



Used product:

1 x RIDE recessed 17W oval $34^\circ + 15^\circ$
 Tablesize: L 2,5m x W 1m x H 0,8m
 Em: 507lx

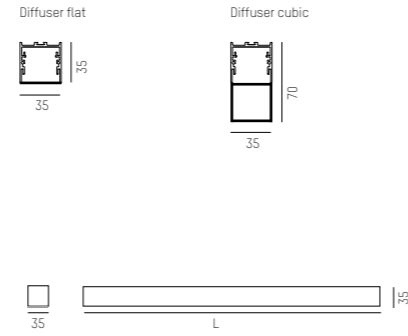

RIDE SD

220-240V AC/DC · CRI >90 · Binning SDCM 3

SYS 10W (nicht dimmbar/not dimmable)

1:	W2 = 820lm	W3 = 890lm	W4 = 930lm
2:	W2 = 920lm	W3 = 1010lm	W4 = 1050lm
3:	W2 = 780lm	W3 = 850lm	W4 = 880lm

577-01001C023XX0	W2	L: 577mm
577-01001C029XX0	W3	L: 577mm
577-01001C024XX0	W4	L: 577mm

SYS 15W

1:	W2 = 1230lm	W3 = 1340lm	W4 = 1400lm
2:	W2 = 1390lm	W3 = 1510lm	W4 = 1570lm
3:	W2 = 1170lm	W3 = 1270lm	W4 = 1320lm

577-01002C023XXY	W2	L: 857mm
577-01002C029XXY	W3	L: 857mm
577-01002C024XXY	W4	L: 857mm

SYS 19W

1:	W2 = 1650lm	W3 = 1790lm	W4 = 1860lm
2:	W2 = 1850lm	W3 = 2020lm	W4 = 2100lm
3:	W2 = 1560lm	W3 = 1700lm	W4 = 1770lm

577-01003C023XXY	W2	L: 1137mm
577-01003C029XXY	W3	L: 1137mm
577-01003C024XXY	W4	L: 1137mm

SYS 24W

1:	W2 = 2060lm	W3 = 2240lm	W4 = 2330lm
2:	W2 = 2320lm	W3 = 2520lm	W4 = 2620lm
3:	W2 = 1950lm	W3 = 2120lm	W4 = 2210lm

577-01004C023XXY	W2	L: 1417mm
577-01004C029XXY	W3	L: 1417mm
577-01004C024XXY	W4	L: 1417mm

SYS 48W

1:	W2 = 4130lm	W3 = 4490lm	W4 = 4670lm
2:	W2 = 4640lm	W3 = 5050lm	W4 = 5250lm
3:	W2 = 3910lm	W3 = 4250lm	W4 = 4420lm

577-01005C023XXY	W2	L: 2817mm
577-01005C029XXY	W3	L: 2817mm
577-01005C024XXY	W4	L: 2817mm

SYS 78W

1:	W2 = 6190lm	W3 = 6730lm	W4 = 7000lm
2:	W2 = 6970lm	W3 = 7570lm	W4 = 7870lm
3:	W2 = 5870lm	W3 = 6380lm	W4 = 6640lm

577-01006C023XXY	W2	L: 4217mm
577-01006C029XXY	W3	L: 4217mm
577-01006C024XXY	W4	L: 4217mm

LED Lichtprofil aus stranggepresstem Aluminium
Oberfläche eloxiert, weiß oder schwarz pulverbeschichtet
LED Konverter im Leuchtenprofil integriert
Für Decken- und Wandmontage geeignet
Flache oder vorspringende kubische Abdeckung

Extruded aluminium LED profile
Anodised, white or black powder coated finish
Built-in LED converter in profile
For ceiling and wall mount
Flat or cubic diffuser

Profilo in alluminio pressofuso a LED
Finitura anodizzata, verniciatura a polveri bianca o nera
Converter LED integrato nel profilo
Per installazione a soffitto e a parete
Diffusore piatto o cubico

Profil en aluminium pressé de LED
Finis anodisé, vernissage à poudres blanc ou noir
Convertisseur intégré dans le profil
Pour installation à plafond ou paroi
Diffuseur plat ou cubique

W2 = LED 2700K
W3 = LED 3000K
W4 = LED 4000K

A++ - A

IP20 CE

ARTIKELNUMMER ERGÄNZEN / COMPLETE CODE

C = ABDECKUNG / COVER

XX = FARBE / COLOUR

Y = DIMMBAR / DIMMABLE

PMMA opal diffuser flat = 1

W white = 05

S switchable = 0

PMMA opal diffuser cubic = 2

S black = 06

D DALI dimm = d

Microprismatic cover flat = 3

AE aluminium anodized = 08

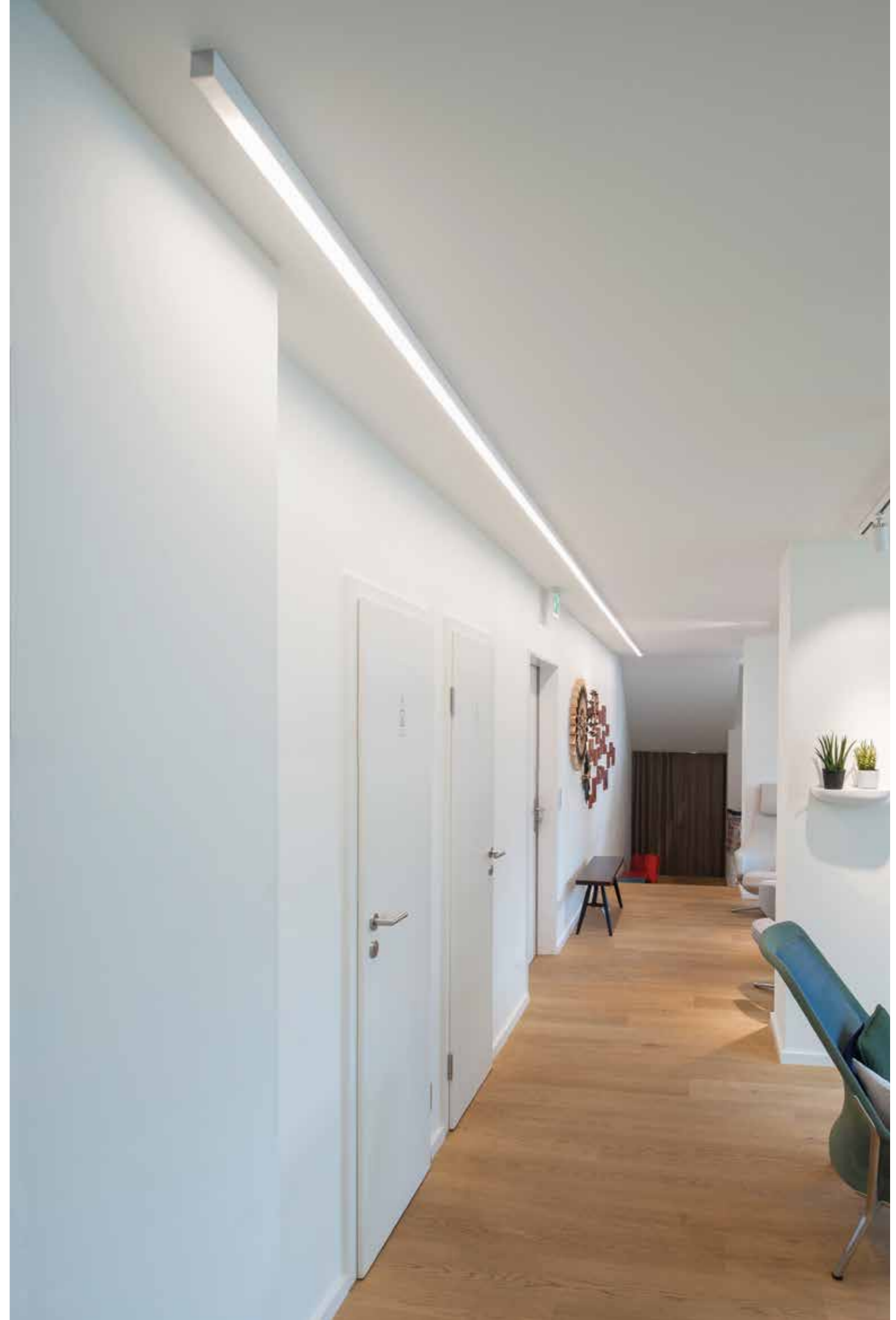

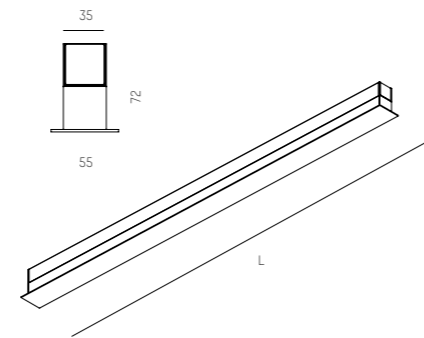
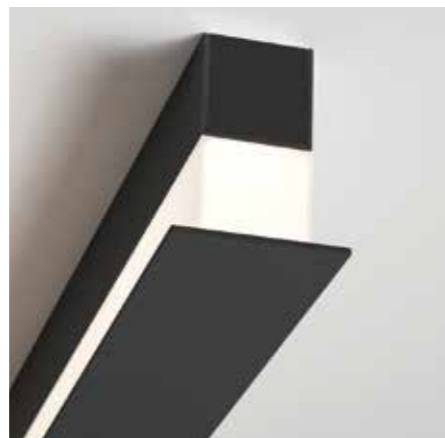
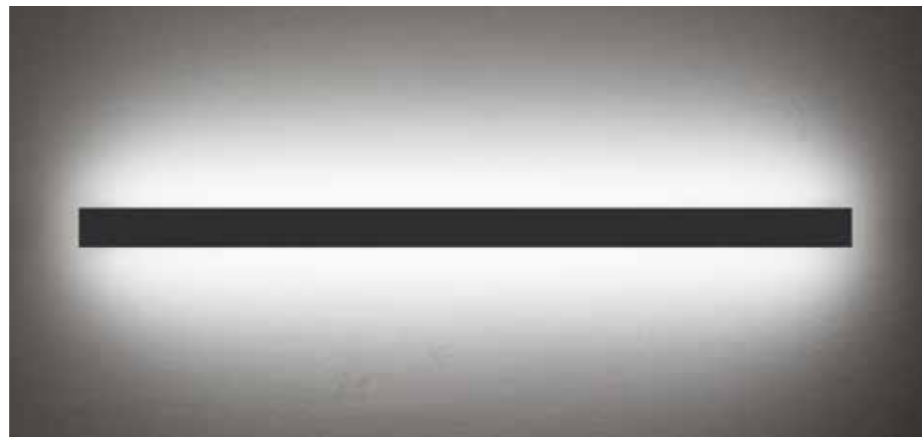

LED Lichtprofil aus stranggepresstem Aluminium
 Oberfläche eloxiert, weiß oder schwarz pulverbeschichtet
 LED Konverter im Leuchtenprofil integriert
 Für Decken- und Wandmontage geeignet
 Kubische Abdeckung mit Blende

Extruded aluminium LED profile
 Anodised, white or black powder coated finish
 Built-in LED converter in profile
 For ceiling and wall mount
 Cubic diffuser with cover

Profilo in alluminio pressofuso a LED
 Finitura anodizzata, verniciatura a polveri bianca o nero
 Converter LED integrato nel profilo
 Per installazione a soffitto e a parete
 Diffusore cubico ad blenda

Profil en aluminium pressé de LED
 Finis anodisé, vernissage à poudres blanc ou noir
 Convertiseur intégré dans le profil
 Pour installation à plafond ou paroi
 Diffuseur cubique avec blende

W2 = LED 2700K
 W3 = LED 3000K
 W4 = LED 4000K

A++ - A

IP20 CE

RIDE BLIND SI

220-240V AC/DC · CRI >90 · Binning SDCM 3

SYS 10W (nicht dimmbar/not dimmable)

577-008012023XX0 W2 460lm L: 597mm
 577-008012029XX0 W3 500lm L: 597mm
 577-008012024XX0 W4 520lm L: 597mm

SYS 15W

577-008022023XXY W2 690lm L: 877mm
 577-008022029XXY W3 750lm L: 877mm
 577-008022024XXY W4 780lm L: 877mm

SYS 19W

577-008032023XXY W2 920lm L: 1157mm
 577-008032029XXY W3 1000lm L: 1157mm
 577-008032024XXY W4 1040lm L: 1157mm

SYS 24W

577-008042023XXY W2 1150lm L: 1437mm
 577-008042029XXY W3 1250lm L: 1437mm
 577-008042024XXY W4 1300lm L: 1437mm

ARTIKELNUMMER ERGÄNZEN / COMPLETE CODE

XX = FARBE/COLOUR

Y = DIMMBAR/DIMMABLE

W white = 05
 S black = 06
 AE aluminium anodized = 08

S switchable = 0
 D DALI dimm = d



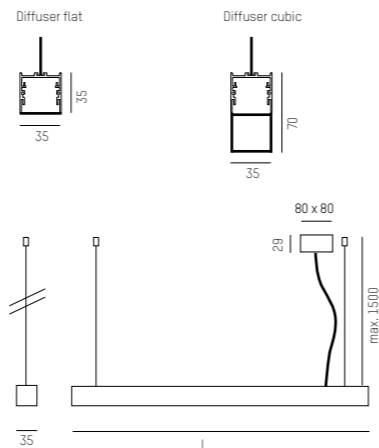

RIDE PD

220-240V AC/DC · CRI >90 · Binning SDCM 3

SYS 15W

1:	W2 = 1230lm	W3 = 1340lm	W4 = 1400lm
2:	W2 = 1390lm	W3 = 1510lm	W4 = 1570lm
3:	W2 = 1170lm	W3 = 1270lm	W4 = 1320lm

577-01202C023XXY	W2	L: 857mm
577-01202C029XXY	W3	L: 857mm
577-01202C024XXY	W4	L: 857mm

SYS 19W

1:	W2 = 1650lm	W3 = 1790lm	W4 = 1860lm
2:	W2 = 1850lm	W3 = 2020lm	W4 = 2100lm
3:	W2 = 1560lm	W3 = 1700lm	W4 = 1770lm

577-01203C023XXY	W2	L: 1137mm
577-01203C029XXY	W3	L: 1137mm
577-01203C024XXY	W4	L: 1137mm

SYS 24W

1:	W2 = 2060lm	W3 = 2240lm	W4 = 2330lm
2:	W2 = 2320lm	W3 = 2520lm	W4 = 2620lm
3:	W2 = 1950lm	W3 = 2120lm	W4 = 2210lm

577-01204C023XXY	W2	L: 1417mm
577-01204C029XXY	W3	L: 1417mm
577-01204C024XXY	W4	L: 1417mm

SYS 48W

1:	W2 = 4130lm	W3 = 4490lm	W4 = 4670lm
2:	W2 = 4640lm	W3 = 5050lm	W4 = 5250lm
3:	W2 = 3910lm	W3 = 4250lm	W4 = 4420lm

577-01205C023XXY	W2	L: 2817mm
577-01205C029XXY	W3	L: 2817mm
577-01205C024XXY	W4	L: 2817mm

SYS 71W

1:	W2 = 6190lm	W3 = 6730lm	W4 = 7000lm
2:	W2 = 6970lm	W3 = 7570lm	W4 = 7870lm
3:	W2 = 5870lm	W3 = 6380lm	W4 = 6640lm

577-01206C023XXY	W2	L: 4217mm
577-01206C029XXY	W3	L: 4217mm
577-01206C024XXY	W4	L: 4217mm

LED Lichtprofil aus stranggepresstem Aluminium
Oberfläche eloxiert, weiß oder schwarz pulverbeschichtet
LED Konverter im Leuchtenprofil integriert
Für Montage als Hängeleuchte
Flache oder vorspringende kubische Abdeckung

Extruded aluminium LED profile
Anodised, white or black powder coated finish
Built-in LED converter in profile
For ceiling mount
Flat or cubic diffuser

Profilo in alluminio pressofuso a LED
Finitura anodizzata, verniciatura a polveri bianca o nero
Converter LED integrato nel profilo
Per installazione a parete
Diffusore piatto o cubico

Profil en aluminium pressé de LED
Finis anodisé, vernissage à poudres blanc ou noir
Convertisseur intégré dans le profil
Pour installation à plafond
Diffuseur plat ou cubique

W2 = LED 2700K
W3 = LED 3000K
W4 = LED 4000K

A++ - A

IP20 CE

ARTIKELNUMMER ERGÄNZEN / COMPLETE CODE

C = ABDECKUNG / COVER

XX = FARBE / COLOUR

Y = DIMMBAR / DIMMABLE

PMMA opal diffuser flat = 1

W white = 05

S switchable = 0

PMMA opal diffuser cubic = 2

S black = 06

D DALI dimm = d

Microprismatic cover flat = 3

AE aluminium anodized = 08





LED Lichtprofil aus stranggepresstem Aluminium
 Oberfläche schwarz eloxiert oder weiß pulverbeschichtet
 Zurückversetzte Linsen, mit schwarzem Raster
 Direkt und indirekte Lichtverteilung

Extruded aluminium LED profile
 Anodised black surface or white powder-coated
 Recessed lense in combination with louvre
 Direct and indirect light beam

Profilo in alluminio pressofuso a LED
 Anodizzato nero o verniciato a polveri in bianco
 Lente retrocessa combinata con griglia nera
 Luce diretta ed indiretta

Profil en aluminium pressé de LED
 Anodisé noir ou vernissé à poudres en blanc
 Optique placée en fond combiné avec darklight
 Lumière directe et indirecte

UGR < 19

W2 = LED 2700K
 W3 = LED 3000K
 W4 = LED 4000K

A+ - A

IP 20  

RIDE LENS HOME PDI

220-240V AC/DC · CRI >90 · Binning SDCM 3

SYS 22W

634-003010323XXY  1920lm
 634-003010329XXY  2090lm
 634-003010324XXY  2220lm

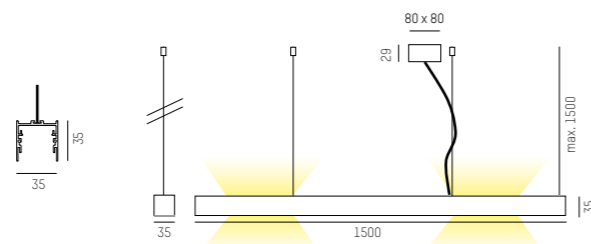

ARTIKELNUMMER ERGÄNZEN / COMPLETE CODE

XX = FARBE/COLOUR

Y = DIMMBAR/DIMMABLE

W white = 05
 SE black anodized = 06

S switchable = 0
 D DALI dimm = d

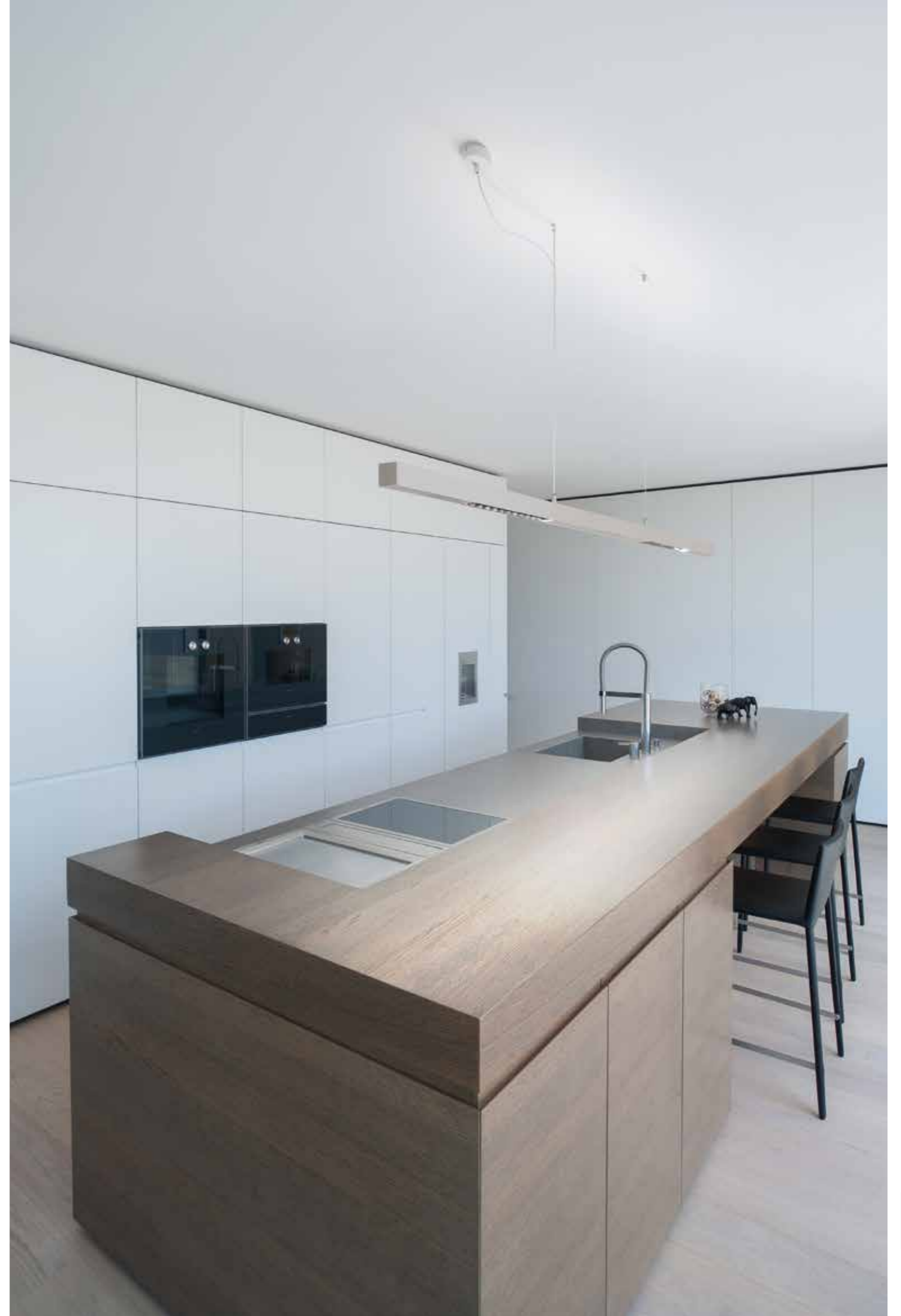

RIDE RING

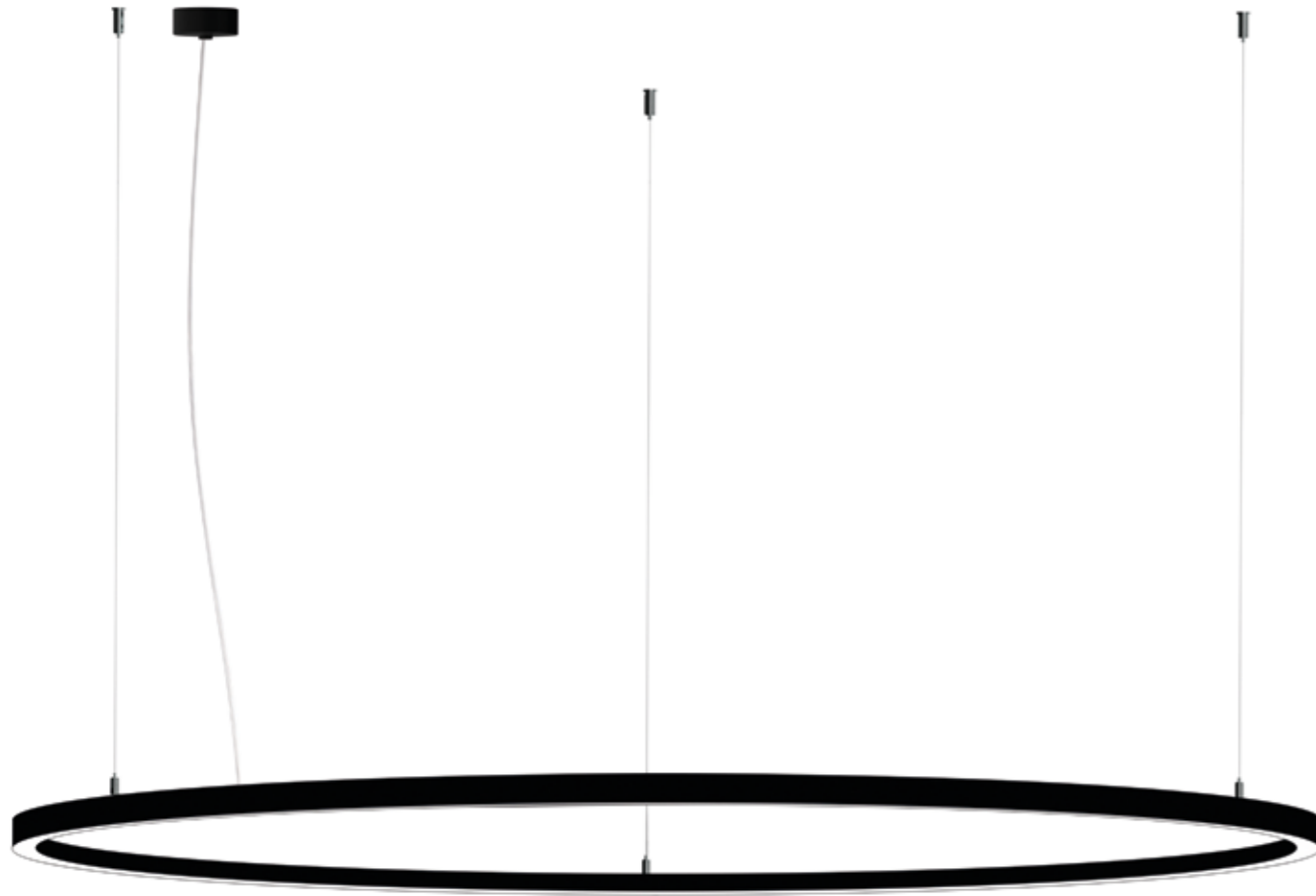

PERFECTLY ROUNDED

Ride Ring – die perfekte Ergänzung zur Produktfamilie Ride. Mit einem Querschnitt von nur 35x35mm, ist die Leuchte eines der schlanksten LED-Lichtsysteme, die derzeit angeboten werden. Der Ring ist in den zwei Durchmessern 750 mm und 1450 mm als Pendel- sowie Aufbauleuchte erhältlich. Der im Profil verbaute Konverter ermöglicht einen minimalistischen Baldachin, der die Leuchte bis ins letzte Detail perfektioniert. Es kann zwischen den Farben Schwarz, Weiß und Aluminium eloxiert gewählt werden. Um Ride Ring ebenso als Systemleuchte anwenden zu können, ist ein jeweils in den zwei Durchmessern erhältliches 90° und 180° Kreissegment verfügbar, welche sich variabel mit oder ohne den dazu passenden linearen Profilen zu vielseitigen Formen verbinden lassen. Planer und Architekten können mit diesem System ihrer Kreativität freien Lauf lassen. Mit Ride Ring als Einzelleuchte oder im System, können unterschiedliche Erfordernisse von Projekten bestens abgedeckt werden.

Ride Ring – the perfect addition to the Ride product family by Molto Luce. With a profile of only 35x35 mm, this luminaire is one of the slimmest LED lighting systems currently on the market. The ring is available as a pendant or surface luminaire in two diameters, 750 mm and 1450 mm. The converter built into the body creates a minimalist ceiling base, which perfects the lighting effect down to the tiniest detail. There is a choice of black, white and aluminium anodized colours. To use Ride Ring as system luminaire as well, a 90° and 180° circular segment is available in the two diameters, which can be variably connected variably, with or without the relevant linear profiles to create a variety of shapes. Planners and architects can give their creativity free rein with this system. With Ride Ring as an individual luminaire or in a system, different project requirements can be optimally covered.

Design: INHOUSE

RIDE RING PENDANT

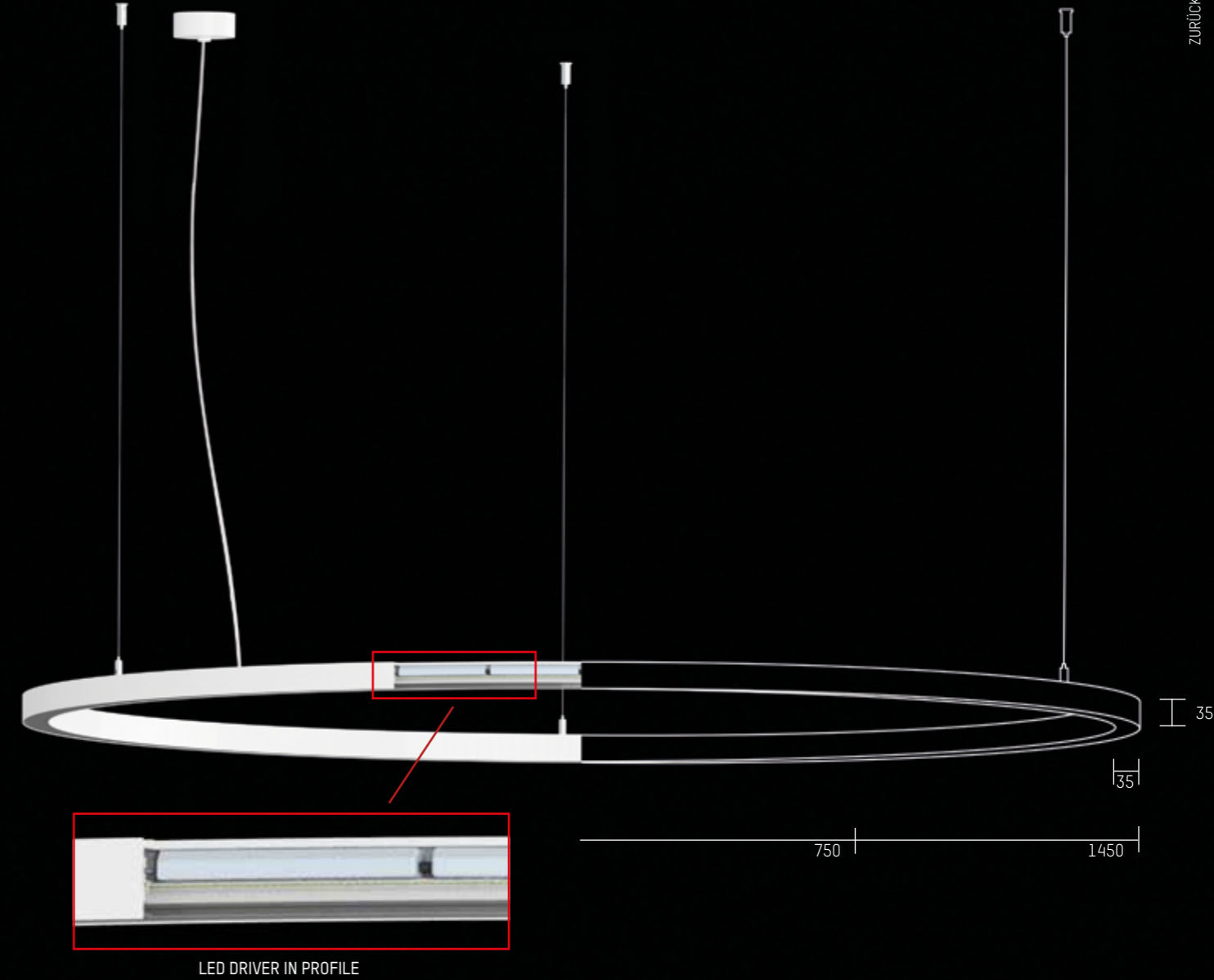

RIDE RING SURFACE



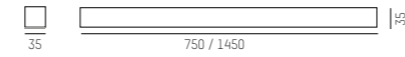
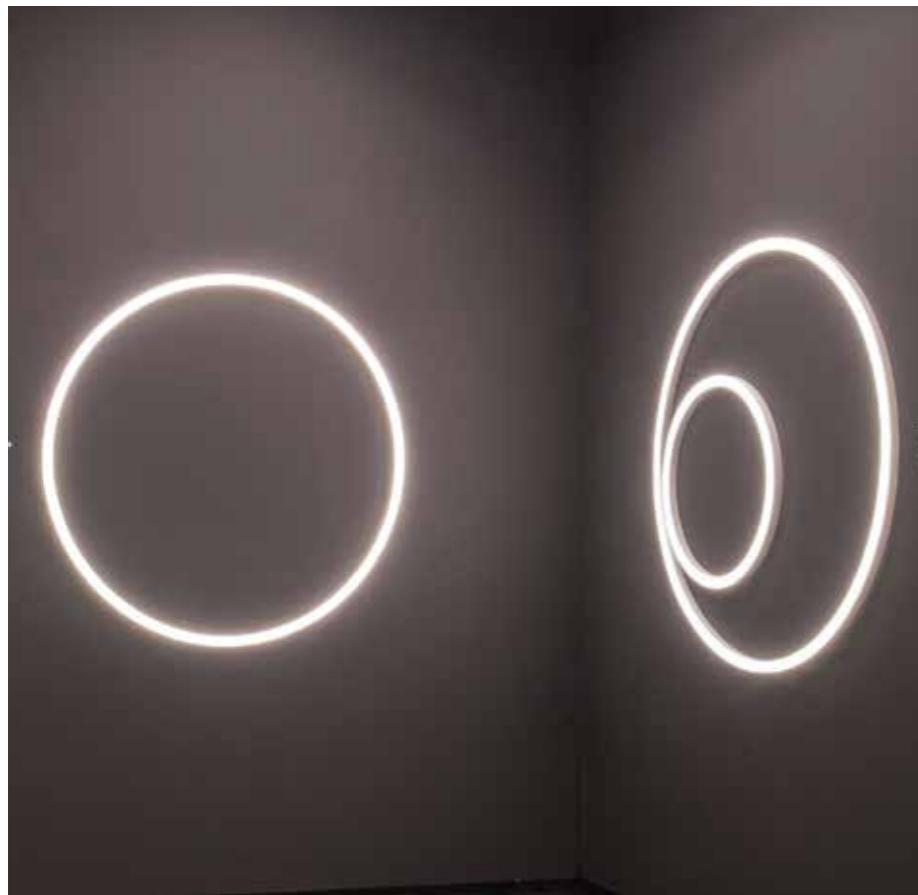

LED Ringleuchte aus stranggepresstem Aluminium
 Oberfläche eloxiert, weiß oder schwarz pulverbeschichtet
 LED Konverter im Leuchtenprofil integriert
 Für Decken- und Wandmontage geeignet
 Inkl. flache PMMA-Abdeckung

LED ring luminaire, extruded aluminium
 Anodised surface, white or black powder-coated
 Built-in LED converter in profile
 suitable for wall and ceiling installation
 Incl. flat PMMA diffuser

Lampada in alluminio estruso a forma di anello
 Superficie anodizzata o verniciata a polvere in bianco o nero
 Converter LED integrato nel profilo
 Adatta per il montaggio a parete o a soffitto
 Incl. copertura piatta in PMMA

Lampe en forme d'anneau en aluminium extrudé
 Finition anodisée ou laquée blanc ou noir
 Convertisseur intégré dans le profil
 Incl. couvercle plat en PMMA

W2 = LED 2700K
 W3 = LED 3000K
 W4 = LED 4000K

A+ - A

IP 20 CE

RIDE RING SD

220-240V AC/DC · CRI >90 · Binning SDCM 3 · DALI dimm.

SYS 38W / Ø 750mm	lm W2	lm W3	lm W4
675-10101102WXXd	3300	3590	3730

SYS 76W / Ø 1450mm	lm W2	lm W3	lm W4
675-10201102WXXd	6610	7180	7470

ARTIKELNUMMER ERGÄNZEN / COMPLETE CODE

W = LICHTFARBE/LIGHT COLOUR

XX = FARBE/COLOUR

W2 LED 2700K = 3
 W3 LED 3000K = 9
 W4 LED 4000K = 4

W white = 05
 S black = 06
 AE aluminium anodized = 08

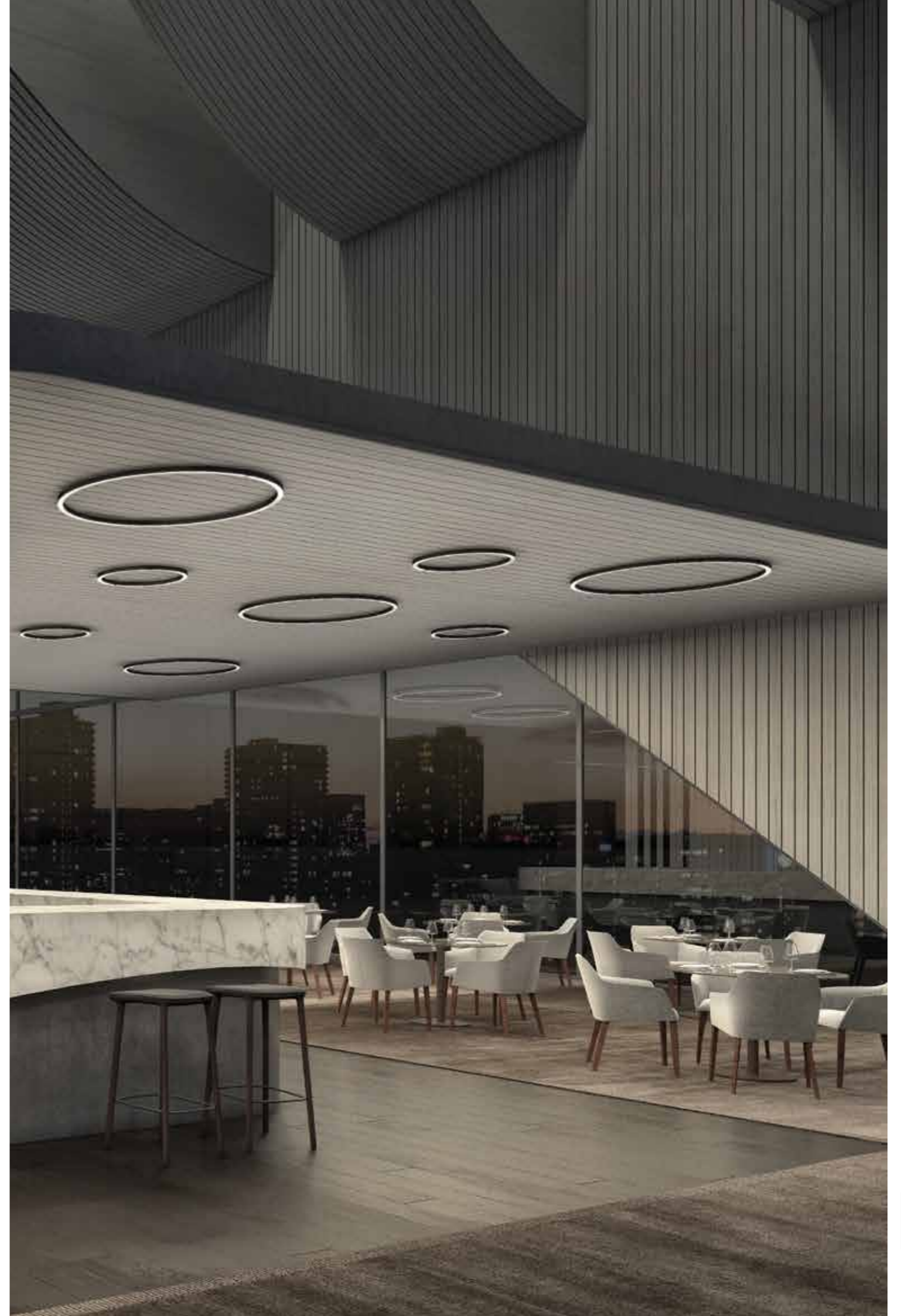

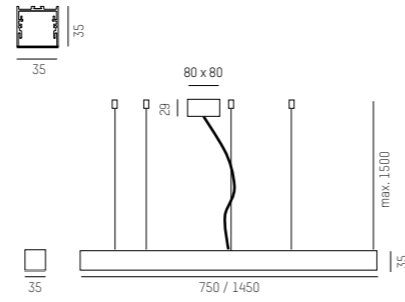
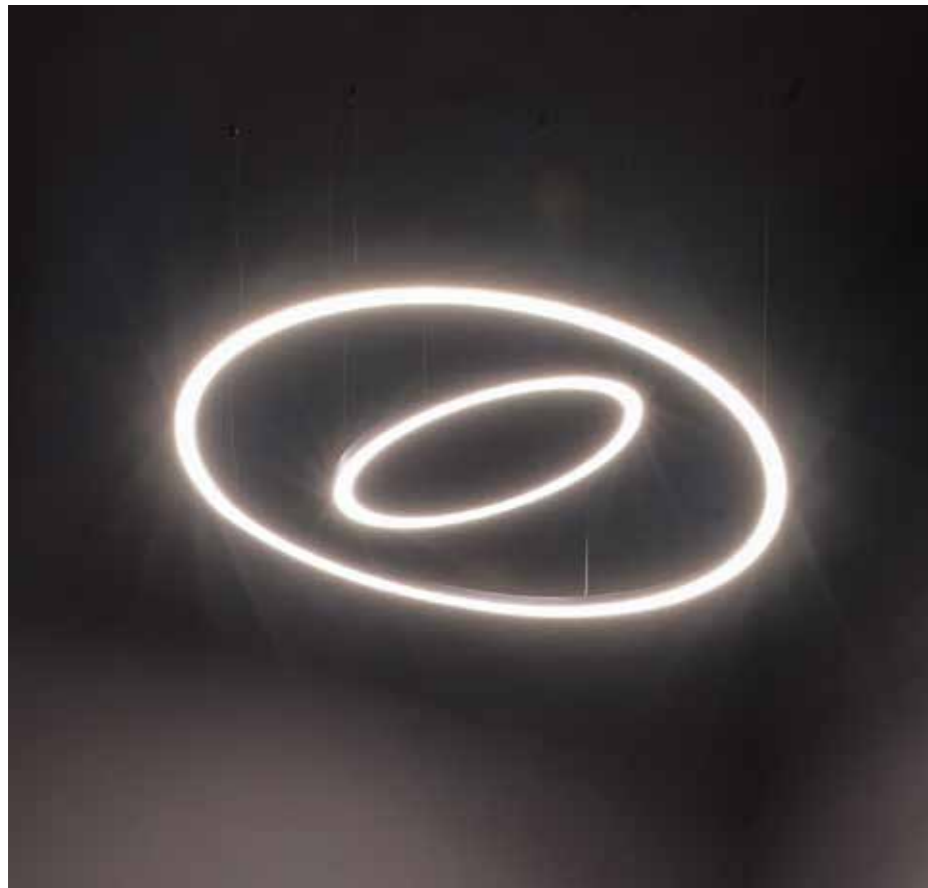

LED Ringleuchte aus stranggepresstem Aluminium
 Oberfläche eloxiert, weiß oder schwarz pulverbeschichtet
 LED Konverter im Leuchtenprofil integriert
 Inkl. flache PMMA-Abdeckung

LED ring luminaire, extruded aluminium
 Anodised surface, white or black powder-coated
 Built-in LED converter in profile
 Incl. flat PMMA diffuser

Lampada in alluminio estruso a forma di anello
 Superficie anodizzata o verniciata a polvere in bianco o nero
 Converter LED integrato nel profilo
 Incl. copertura piatta in PMMA

Lampe en forme d'anneau en aluminium extrudé
 Finition anodisée ou laquée blanc ou noir
 Convertiseur intégré dans le profil
 Incl. couvercle plat en PMMA

W2 = LED 2700K
 W3 = LED 3000K
 W4 = LED 4000K

A+ - A

IP20

RIDE RING PD

220-240V AC/DC · CRI >90 · Binning SDCM 3 · DALI dimm.

SYS 38W / Ø 750mm	lm W2	lm W3	lm W4
675-20101102WXXd	3300	3590	3730

SYS 76W / Ø 1450mm	lm W2	lm W3	lm W4
675-20201102WXXd	6610	7180	7470

ARTIKELNUMMER ERGÄNZEN / COMPLETE CODE

W = LICHTFARBE/LIGHT COLOUR

W2 LED 2700K = 3
 W3 LED 3000K = 9
 W4 LED 4000K = 4

XX = FARBE/COLOUR

W white = 05
 S black = 06
 AE aluminium anodized = 08

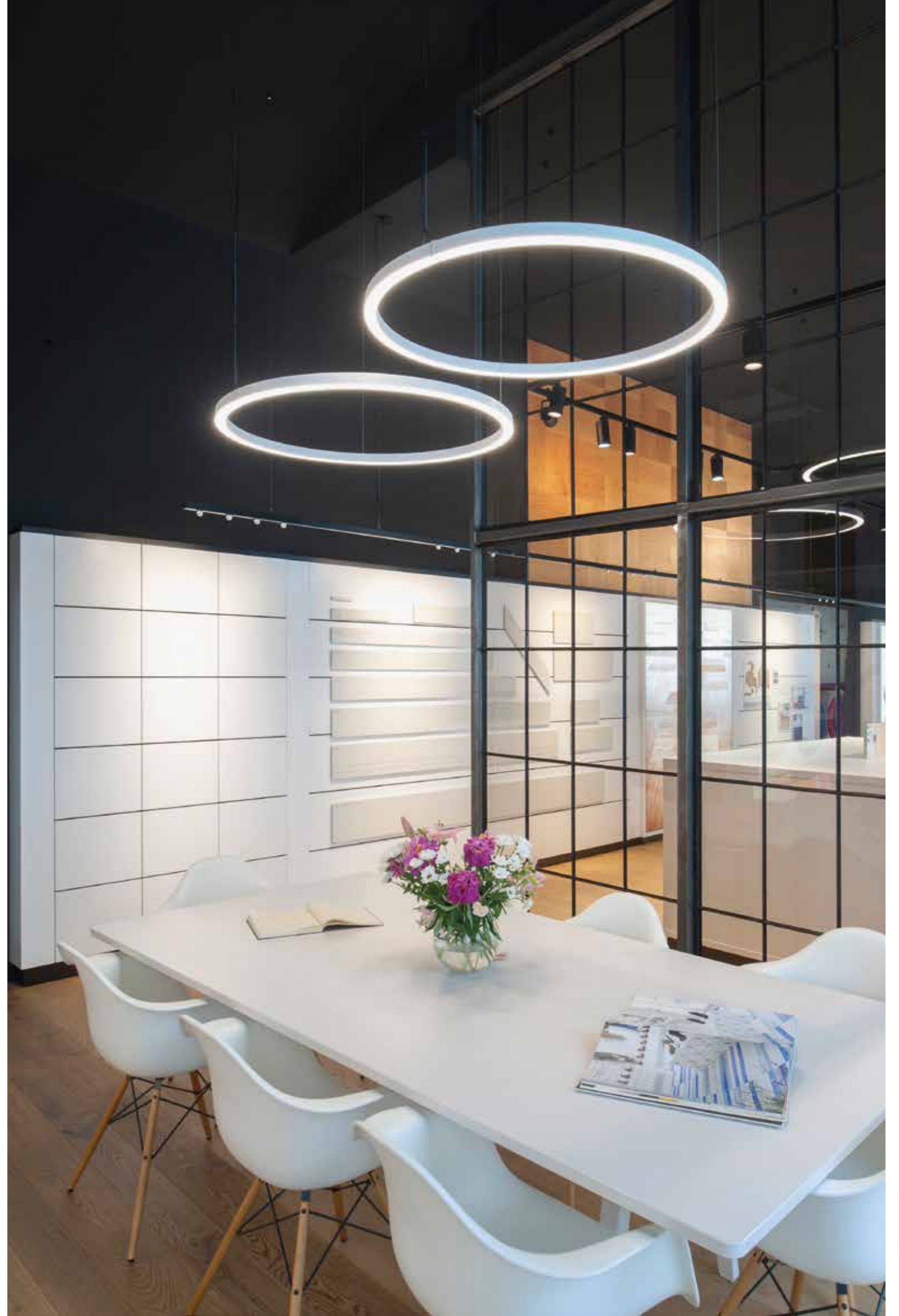

RIDE SYSTEM

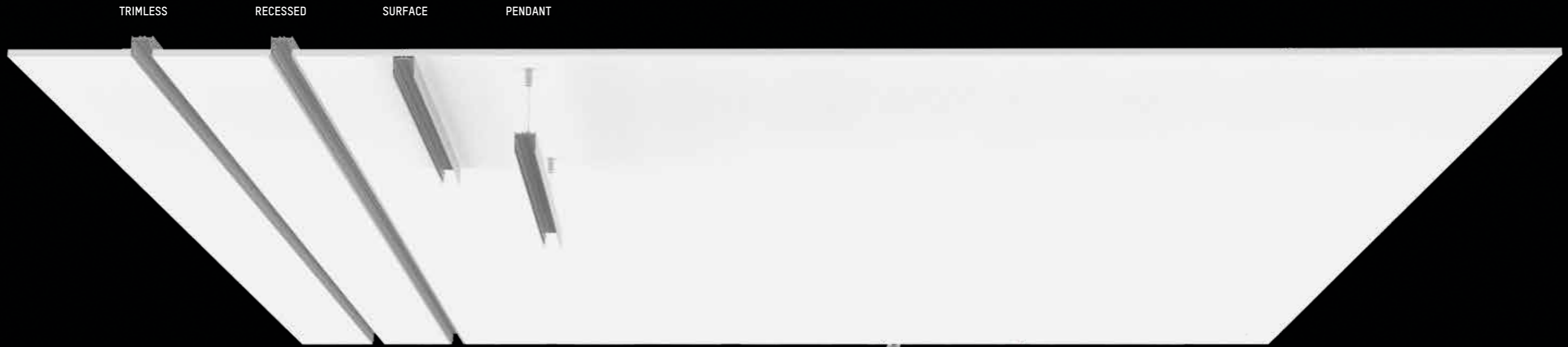

TRIMLESS RECESSED SURFACE PENDANT

LED LIGHT INSERT ALUMINIUM COVER RIDE SPOT RIDE RDB RIDE LENS RIDE LENS TURN DASH GRID TRIGGA

OPAL FLAT MICROPRISMATIC FLAT OPAL CUBIC

RIDE RING SURFACE

RIDE RING PENDANT

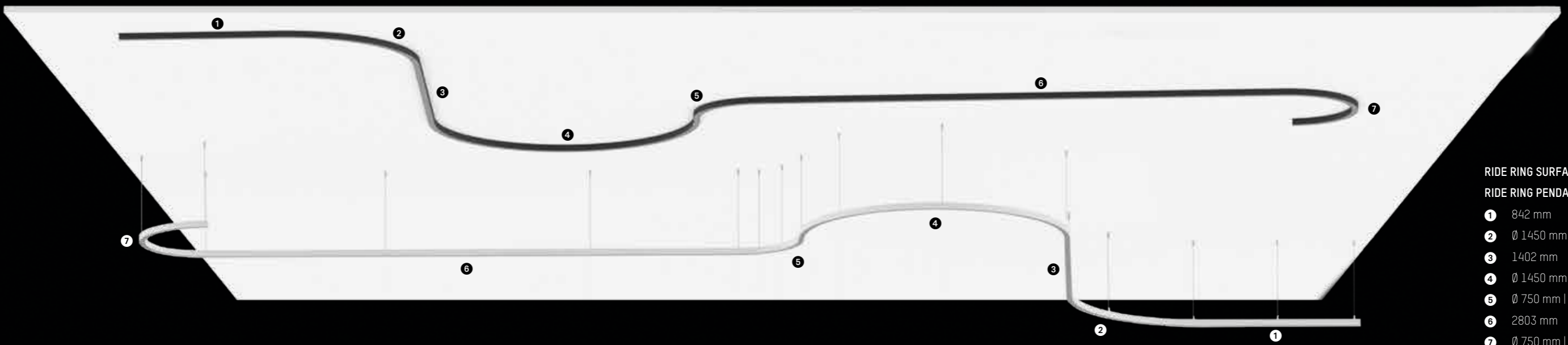

- RIDE RING SURFACE:
RIDE RING PENDANT:
- 1 842 mm
 - 2 \emptyset 1450 mm | 90°
 - 3 1402 mm
 - 4 \emptyset 1450 mm | 180°
 - 5 \emptyset 750 mm | 90°
 - 6 2803 mm
 - 7 \emptyset 750 mm | 180°

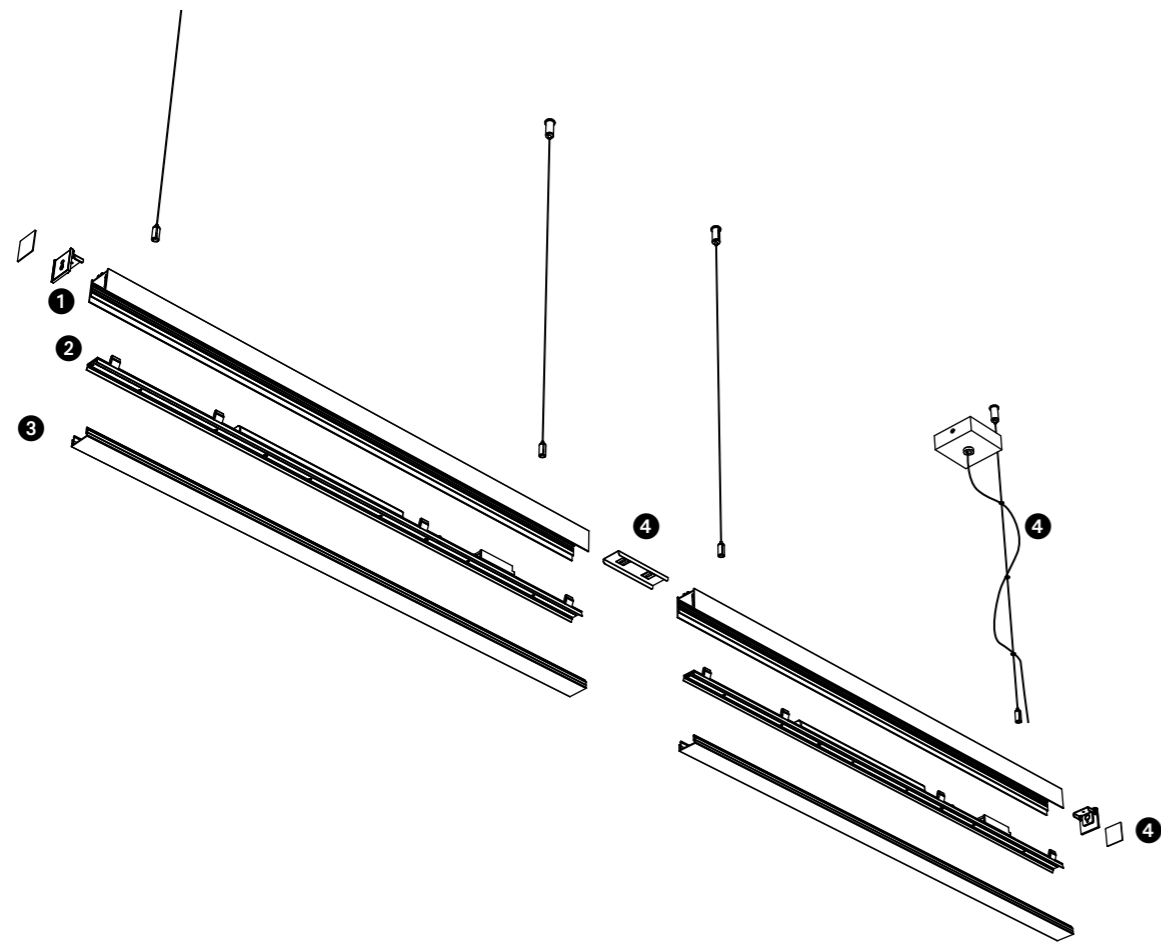

1. PROFILES

PROFILE SYSTEM SURFACE

PROFILE SYSTEM RECESSED

PROFILE SYSTEM RECESSED TRIMLESS

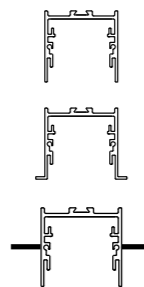

INFO: BETONEINBAU AUF ANFRAGE
INFO: CONCRETE MOUNTING ON REQUEST

3. COVERS

PMMA COVER OPAL FLAT



PMMA COVER OPAL CUBIC

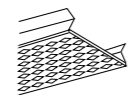

MICROPRISMATIC COVER FLAT



2. INSERTS

LIGHT INSERTS LED

LIGHT INSERTS SPOTS

LIGHT INSERTS RDB

LIGHT INSERTS LENS

LIGHT INSERTS LENS TURN

LIGHT INSERTS DASH

LIGHT INSERTS GRID

LIGHT INSERTS TRIGGA

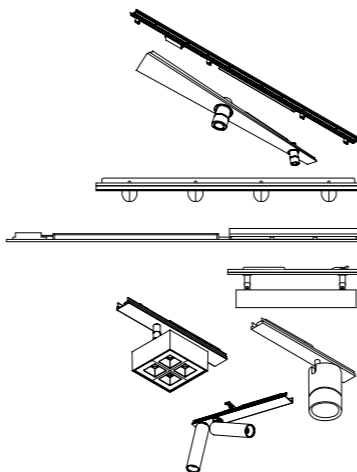

4. COMPONENTS

SUSPENSION

POWER FEED

END PIECE FLAT

END PIECE CUBIC

90° JUNCTION HORIZONTAL

90° JUNCTION VERTICAL

LINEAR JUNCTION

MOUNTING BRACKETS

EARTHING SET

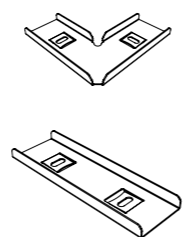

RIDE LENS INSERT



RIDE LENS TURN INSERT



RDB LIGHT INSERT



DASH LIGHT INSERT



GRID LIGHT INSERT



TRIGGA LIGHT INSERT



RIDE SPOT INSERT



RIDE CUBIC COVER

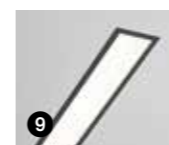

RIDE FLAT COVER

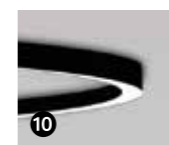

RIDE CURVED

LED Lichtprofil aus stranggepresstem Aluminium
Oberfläche eloxiert, weiß oder schwarz pulverbeschichtet
Montage als Einbau, Aufbau oder abgedeckte Version
Flache oder vorspringende kubische Abdeckung

Extruded aluminium LED profile
Anodised, white or black powder coated finish
Recessed, surface or pendant mounting
Flat or cubic diffuser

Profilo in alluminio pressofuso a LED
Finitura anodizzata, verniciatura a polveri bianca o nero
Montaggio ad incasso, superficie o sospeso
Diffusore piatto o cubico

Profil en aluminium presse' de LED
Finis anodisé, vernissage à poudres blanc ou noir
Encastré, plafonnier ou suspension
Diffuseur plat ou cubique

Die Schutzart IP54 wird nur bei Deckenmontage des
Leuchtensystems gewährleistet
IP54 protection applies for ceiling installation only

Achtung:
Max. zulässige, durchgehende Systemlänge pro Ein-
speisung beträgt 15m (max. 400W)!
Die Durchgangsverdrahtung entspricht einem Quer-
schnitt von 0,75mm²!

Attention:
System length per feed maximal 15m (max. 400W)!
The cross section of the trough wiring is 0,75mm²!

A++ - A

IP 20  

PROFILES

AUFBAUPROFIL SYSTEM / SURFACE PROFILE SYSTEM

Abdeckungen, Lichteinsätze und Zubehör separat ordern, max. Profillänge: 4400mm
order covers, light inserts and components separately, max. profile length: 4400mm
IP54: maximale lineare Länge: 4400mm / maximal linear length: 4400mm

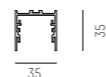

577-410XX L: 4500mm

EINBAUPROFIL SYSTEM / RECESSED PROFILE SYSTEM

Abdeckungen, Lichteinsätze und Zubehör separat ordern, max. Profillänge: 4400mm
order covers, light inserts and components separately, max. profile length: 4400mm
IP54: maximale lineare Länge: 4400mm / maximal linear length: 4400mm

IP54: Einbauversion nur mit flacher Abdeckung möglich / Recessed version only with flat cover





577-411XX L: 4500mm

EINBAUPROFIL RAHMENLOS SYSTEM / RECESSED PROFILE TRIMLESS SYSTEM

Abdeckungen, Lichteinsätze und Zubehör separat ordern, max. Profillänge: 4400mm
order covers, light inserts and components separately, max. profile length: 4400mm
IP54: maximale lineare Länge: 4400mm / maximal linear length: 4400mm

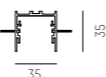
IP54: Einbauversion nur mit flacher Abdeckung möglich / Recessed version only with flat cover



577-320leer  L: 2000mm
577-41200  L: 4500mm

COVERS

PMMA ABDECKUNG OPAL FLACH / PMMA COVER OPAL FLAT

577-42100 L: 4500mm

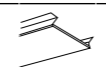

PMMA ABDECKUNG OPAL KUBISCH / PMMA COVER OPAL CUBIC

577-42200 L: 4500mm

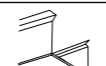

MIKROPRISMENABDECKUNG FLACH / MICROPRISMATIC COVER

577-42300 L: 4500mm

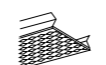

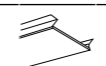

ALUMINIUMABDECKUNG FLACH / ALUMINIUM COVER FLAT

577-485XX L: 4500mm



ARTIKELNUMMER ERGÄNZEN / COMPLETE CODE

XX = FARBE/COLOUR

 white = 05
 black = 06
 aluminium anodized = 08

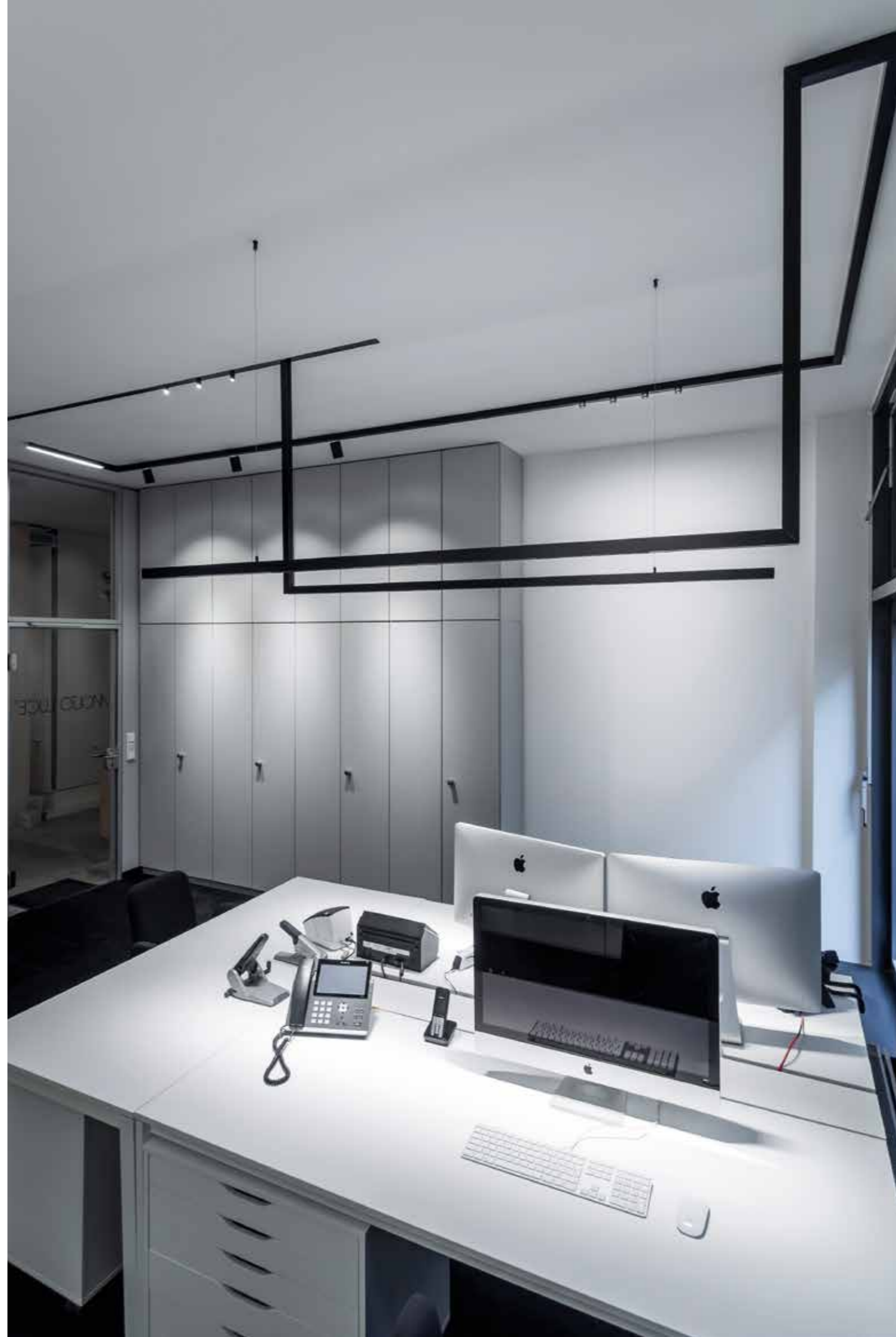

SYSTEM COMPONENTS

RIDE SYSTEM + RIDE RING SYSTEM ABHÄNGUNG HÖHENVERSTELLBAR / SUSPENSION ADJUSTABLE IN HEIGHT

H: max. 1500mm, Abstand max. 1500mm / distance max. 1500mm

577-4905 577-4906 577-4904

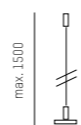

RIDE SYSTEM + RIDE RING SYSTEM EINSPEISUNG / POWER FEED

H: max. 1500mm; 3 x 0,75mm²

577-4805 577-4806 577-4804

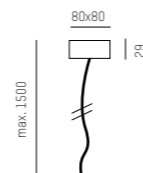

H: max. 1500mm; 5 x 0,75mm²; für dimm. / for dimm.

577-4815 577-4816 577-4814

RIDE SYSTEM + RIDE RING SYSTEM ENDECKEL FLACH AUFBAU / END PIECE FLAT SURFACE

IP 20 oder IP54 Installationen, Set 2 Stk. / IP20 or IP54 installation, set 2 pcs.

577-4605 577-4606 577-4604

577-4615 IP54 577-4616 IP54 577-4614 IP54

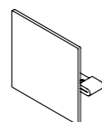

RIDE SYSTEM ENDECKEL KUBISCH AUFBAU / END PIECE CUBIC SURFACE

IP 20 oder IP54 Installationen, Set 2 Stk. / IP20 or IP54 installation, set 2 pcs.

577-4625 577-4626 577-4624

577-4635 IP54 577-4636 IP54 577-4634 IP54



RIDE SYSTEM ENDECKEL FLACH EINBAU / END PIECE FLAT RECESSED

IP 20 oder IP54 Installationen, Set 2 Stk. / IP20 or IP54 installation, set 2 pcs.

577-4705 577-4706 577-4704

577-4715 IP54 577-4716 IP54 577-4714 IP54

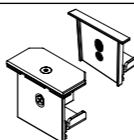

RIDE SYSTEM ENDECKEL EINBAU RAHMENLOS / END PIECE RECESSED TRIMLESS

IP 20 Installationen, Set 2 Stk. / IP20 installation, set 2 pcs.

577-4720

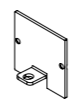

RIDE SYSTEM ENDECKEL FÜR BETONEINBAU / END PIECE FOR CONCRETE

IP 20 Installationen, Set 2 Stk. / IP20 installation, set 2 pcs..

577-4648

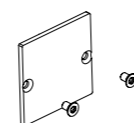

RIDE SYSTEM BETONEINBAU HALTEBÜGEL / HOLDER FOR CONCRETE

Je Meter 1 Bügel, mindestens 3 Stk. pro Profil erforderlich / Order 1 holder per meter, min 3 pcs. needed per profile

577-5100

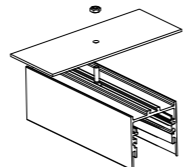

SYSTEM COMPONENTS

RIDE SYSTEM 90° ECKVERBINDER / 90° JUNCTION

Horizontale oder vertikale Installationen, **NUR IP20 GEEIGNET** / horizontal or vertical mounting, **FOR IP20 ONLY**

577-4400 Horizontal / horizontal

577-4410 Vertikal / vertical

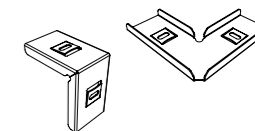

RIDE SYSTEM LINEARVERBINDER INNENLIEGEND / LINEAR JUNCTION IN BOARD

Innenliegend, **NUR IP20 GEEIGNET** / in board, **FOR IP20 ONLY**

577-4300

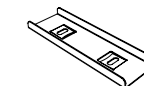

RIDE SYSTEM LINEARVERBINDER INNENLIEGEND FÜR RIDE LENS / LINEAR JUNCTION IN BOARD FOR RIDE LENS

Innenliegend, **NUR IP20 GEEIGNET** / in board, **FOR IP20 ONLY**

634-420

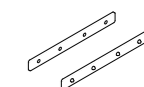

RIDE RING SYSTEM VERBINDER INNENLIEGEND / LINEAR JUNCTION IN BOARD

Innenliegend, **NUR IP20 GEEIGNET** / in board, **FOR IP20 ONLY**

675-421000000000 C-SHAPE 750 - 750
 675-422000000000 C-SHAPE 750 - 1450
 675-423000000000 C-SHAPE 1450 - 1450
 675-424000000000 S-SHAPE 750 - 750
 675-425000000000 S-SHAPE 750 - 1450
 675-426000000000 S-SHAPE 1450 - 1450
 675-427000000000 LINEAR - CURVE 750
 675-428000000000 LINEAR - CURVE 1450

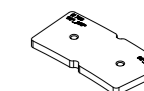
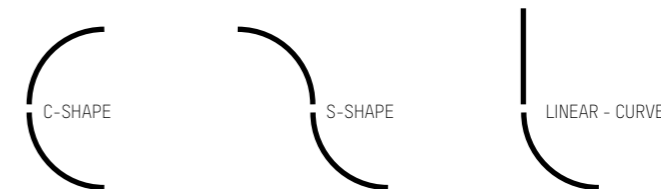

RIDE SYSTEM MONTAGESSET FÜR WAND- / DECKENEINBAU / SET FOR WALL- / CEILING RECESSED MOUNTING

Je Meter 1 Bügel, mindestens 3 Stk. pro Profil erforderlich / Order 1 holder per meter, min 3 pcs. needed per profile

577-5000

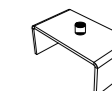

RIDE SYSTEM ERDUNGSSET / EARTHING SET

577-2000

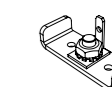

LIGHT INSERTS

1 LICHTEINSÄTZE / LIGHT INSERTS

220-240V AC/DC · CRI >90 · Binning SDCM 3 Durchgangsverdrahtet 0,75mm², steckfertig, inkl. Verbindungsleitungen und Konverter
Feed through wired 0,75mm², ready to plug in, incl. connector cable and converter

A++ - A

Code	W	L	SYS	820lm	920lm	780lm	(nicht dimmbar / not dimmable)
577-001010023080	W2	L: 560mm	SYS 10W	820lm	920lm	780lm	(nicht dimmbar / not dimmable)
577-001010029080	W3	L: 560mm	SYS 10W	890lm	1010lm	850lm	(nicht dimmbar / not dimmable)
577-001010024080	W4	L: 560mm	SYS 10W	930lm	1050lm	880lm	(nicht dimmbar / not dimmable)
<hr/>							
577-00102002308Y	W2	L: 840mm	SYS 15W	1230lm	1390lm	1170lm	
577-00102002908Y	W3	L: 840mm	SYS 15W	1340lm	1510lm	1270lm	
577-00102002408Y	W4	L: 840mm	SYS 15W	1400lm	1570lm	1320lm	
<hr/>							
577-00103002308Y	W2	L: 1120mm	SYS 19W	1650lm	1850lm	1560lm	
577-00103002908Y	W3	L: 1120mm	SYS 19W	1790lm	2020lm	1700lm	
577-00103002408Y	W4	L: 1120mm	SYS 19W	1860lm	2100lm	1770lm	
<hr/>							
577-00104002308Y	W2	L: 1400mm	SYS 24W	2060lm	2320lm	1950lm	
577-00104002908Y	W3	L: 1400mm	SYS 24W	2240lm	2520lm	2120lm	
577-00104002408Y	W4	L: 1400mm	SYS 24W	2330lm	2620lm	2210lm	



2 LICHTEINSÄTZE 2 od. 3 Spots / LIGHT INSERTS 2 or 3 spots

220-240V AC/DC · CRI >90 · Binning SDCM 3 Durchgangsverdrahtet 0,75mm², steckfertig, inkl. Verbindungsleitungen und Konverter (nicht dimmbar)
Feed through wired 0,75mm², ready to plug in, incl. connector cable and converter (not dimmable)

A++ - A

Code	W	L	SYS	290lm	310lm	320lm	
577-002010123XX	W2	L: 420mm	SYS 7W	290lm			
577-002010129XX	W3	L: 420mm	SYS 7W	310lm			
577-002010124XX	W4	L: 420mm	SYS 7W	320lm			
<hr/>							
577-002010223XX	W2	L: 420mm	SYS 7W	290lm			
577-002010229XX	W3	L: 420mm	SYS 7W	310lm			
577-002010224XX	W4	L: 420mm	SYS 7W	320lm			
<hr/>							
577-002020123XX	W2	L: 630mm	SYS 9W	430lm			
577-002020129XX	W3	L: 630mm	SYS 9W	470lm			
577-002020124XX	W4	L: 630mm	SYS 9W	480lm			
<hr/>							
577-002020223XX	W2	L: 630mm	SYS 9W	430lm			
577-002020229XX	W3	L: 630mm	SYS 9W	470lm			
577-002020224XX	W4	L: 630mm	SYS 9W	480lm			

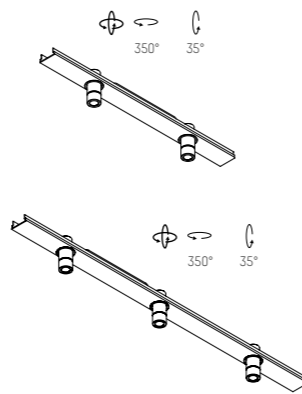

3 RDB LICHTEINSÄTZE / RDB LIGHT INSERTS

220-240V AC/DC · CRI >90 · Binning SDCM 3 Durchgangsverdrahtet 0,75mm², steckfertig, inkl. Verbindungsleitungen und Konverter
Feed through wired 0,75mm², ready to plug in, incl. connector cable and converter

A++ - A

Code	W	L	SYS	1480lm	1600lm	1720lm
577-003010523XXY	W2	L: 630mm	SYS 28W	1480lm		
577-003010529XXY	W3	L: 630mm	SYS 28W	1600lm		
577-003010524XXY	W4	L: 630mm	SYS 28W	1720lm		

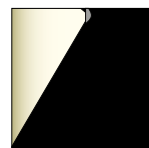
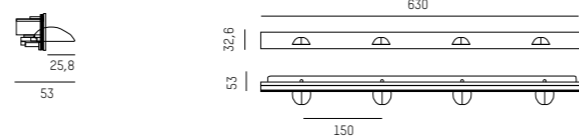

RDB asymmetrical reflector by Bartenbach

ARTIKELNUMMER ERGÄNZEN / COMPLETE CODE

XX = FARBE/COLOUR

Y = DIMMBAR/DIMMABLE

W white = 05
S black = 06
AE aluminium anodized = 08

Ⓢ switchable = 0
Ⓣ DALI dimm = d



1 LED LIGHT INSERT WITH COVER



2 LED LIGHT INSERT WITH SPOTS



3 LED LIGHT INSERT WITH RDB REFLECTOR

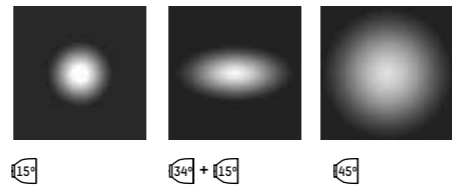

LED Lichteinsatz aus Aluminium
 Oberfläche in weiß, silber oder schwarz pulverbeschichtet
 Zurückversetzte Linsen mit verschiedenen Abstrahlwinkeln
 Perfekte Entblendung und erhöhter Sehkomfort

LED light insert in aluminium
 White, silver or black finish powder coated
 Recessed lenses with different beam-angles
 Perfect glare control and increased visual comfort

Inserto LED in alluminio
 Verniciatura a polveri in bianco, grigio opaco o nero
 Lenti spostati indietro con varie emissioni
 Controllo anti-abbagliamento per un elevato comfort visio

LED insert en aluminium
 Vernissage ó poudres en blanc, gris mat ou noir
 Lentés déplacés au fond avec d'émissions différentes
 Control anti-éblouissement et confort visuel optimal

UGR < 19

W2 = LED 2700K
 W3 = LED 3000K
 W4 = LED 4000K

A++ - A

IP 20

LFO Lens-Technology by Bartenbach

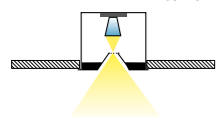

LINSEN LICHTEINSÄTZE / LENS LIGHT INSERTS

220-240V AC/DC · CRI >90 · Binning SDCM 3
 Durchgangsverdrahtet 0,75mm², steckfertig, inkl. Verbindungsleitungen und Konverter
 Feed through wired 0,75mm², ready to plug in, incl. connector cable and converter

SYS 14W

634-001010123XXY	W2	15°	spot	1010lm
634-001010129XXY	W3	15°	spot	1100lm
634-001010124XXY	W4	15°	spot	1190lm

634-001010623XXY	W2	34° + 15°	oval	960lm
634-001010629XXY	W3	34° + 15°	oval	1040lm
634-001010624XXY	W4	34° + 15°	oval	1130lm

634-001010323XXY	W2	45°	flood	1010lm
634-001010329XXY	W3	45°	flood	1130lm
634-001010324XXY	W4	45°	flood	1190lm

SYS 19W

634-001020123XXY	W2	15°	spot	1400lm
634-001020129XXY	W3	15°	spot	1530lm
634-001020124XXY	W4	15°	spot	1650lm

634-001020623XXY	W2	34° + 15°	oval	1330lm
634-001020629XXY	W3	34° + 15°	oval	1450lm
634-001020624XXY	W4	34° + 15°	oval	1560lm

634-001020323XXY	W2	45°	flood	1400lm
634-001020329XXY	W3	45°	flood	1530lm
634-001020324XXY	W4	45°	flood	1650lm

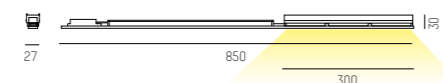

ARTIKELNUMMER ERGÄNZEN / COMPLETE CODE

XX = FARBE/COLOUR

Y = DIMMBAR/DIMMABLE

W white = 05
 S black = 06
 AE aluminium anodized = 08

S switchable = 0
 D DALI dimm = d

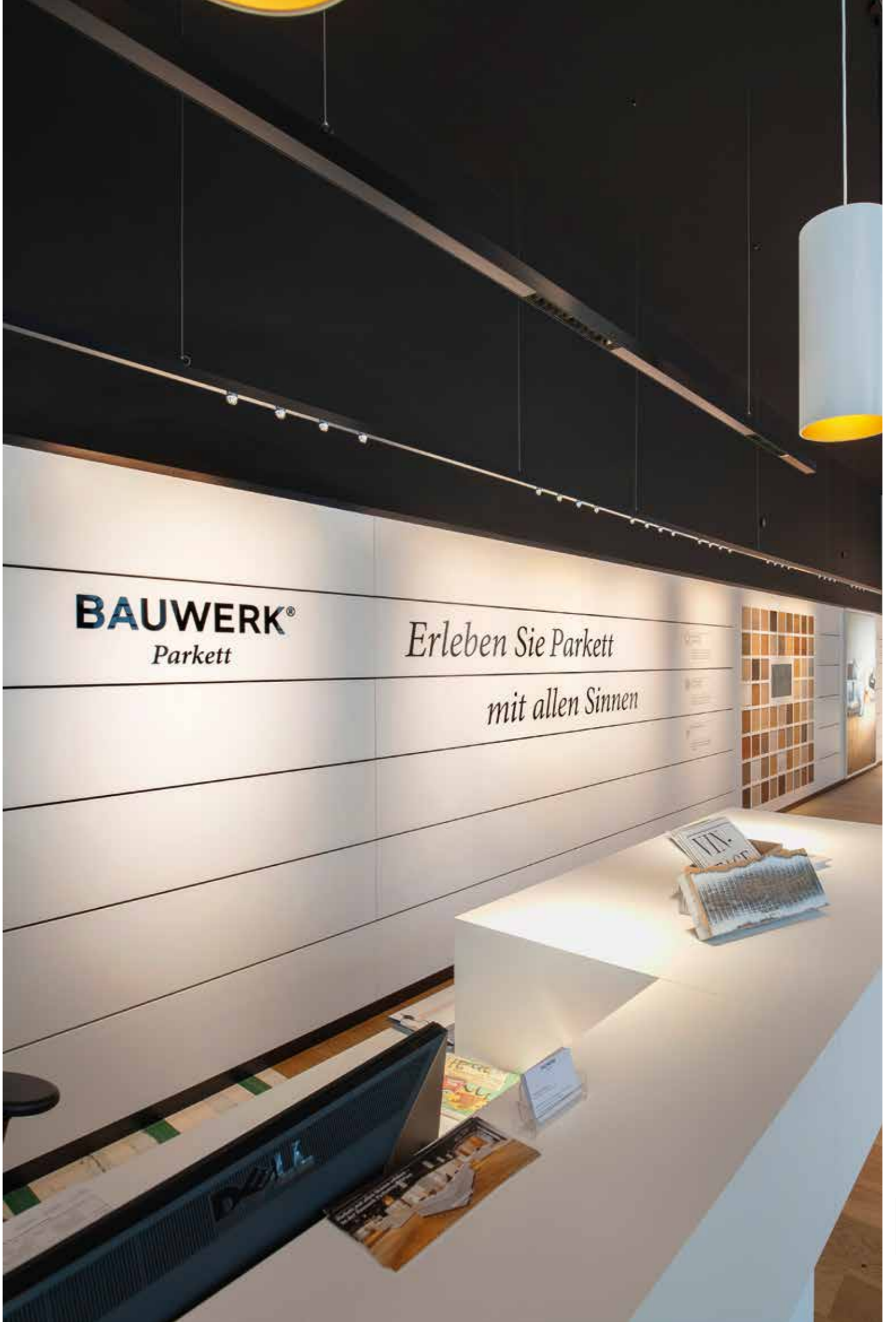



LED Lichteinsatz aus Aluminium
 Oberfläche in weiß, silber oder schwarz pulverbeschichtet
 Zurückversetzte Linsen mit verschiedenen Abstrahlwinkeln
 Lichtaustrittsfläche von nur 10 mm
 Perfekte Entblendung und erhöhter Sehkomfort

LED light insert in aluminium
 White, silver or black finish powder coated
 Recessed lenses with different beam-angles
 light exit field with only 10 mm
 Perfect glare control and increased visual comfort

Inserto LED in alluminio
 Verniciatura a polveri in bianco, grigio opaco o nero
 Lenti spostati indietro con varie emissioni
 Dispositivo d'illuminazione di soli 10 mm
 Controllo anti-abbagliamento per un elevato comfort visivo

LED insert en aluminium
 Vernissage ó poudres en blanc, gris mat ou noir
 Lentés déplacés au fond avec d'émissions différentes
 Plus que 10 mm de surface d'émission de lumière
 Control anti-éblouissement et confort visuel optimal

UGR < 16

W2 = LED 2700K
 W3 = LED 3000K

A++ - A

IP 20 CE

LF0 Lens-Technology by Bartenbach

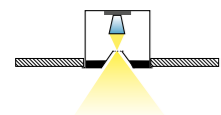

TRIGGA LICHTEINSATZ / TRIGGA LIGHT INSERT

220-240V AC · CRI >90 · Binning SDCM 3

SYS 15W

662-012050223XX0 W2 30° 610lm
 662-012050229XX0 W3 30° 650lm

662-012050523XX0 W2 55° 710lm
 662-012050529XX0 W3 55° 750lm

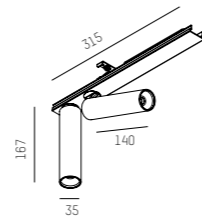

ARTIKELNUMMER ERGÄNZEN / COMPLETE CODE

XX = FARBE / COLOUR

W white = 55
 S black = 66
 S S silver-black = 46

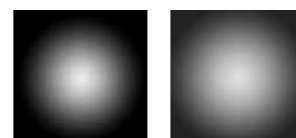

30° 55°

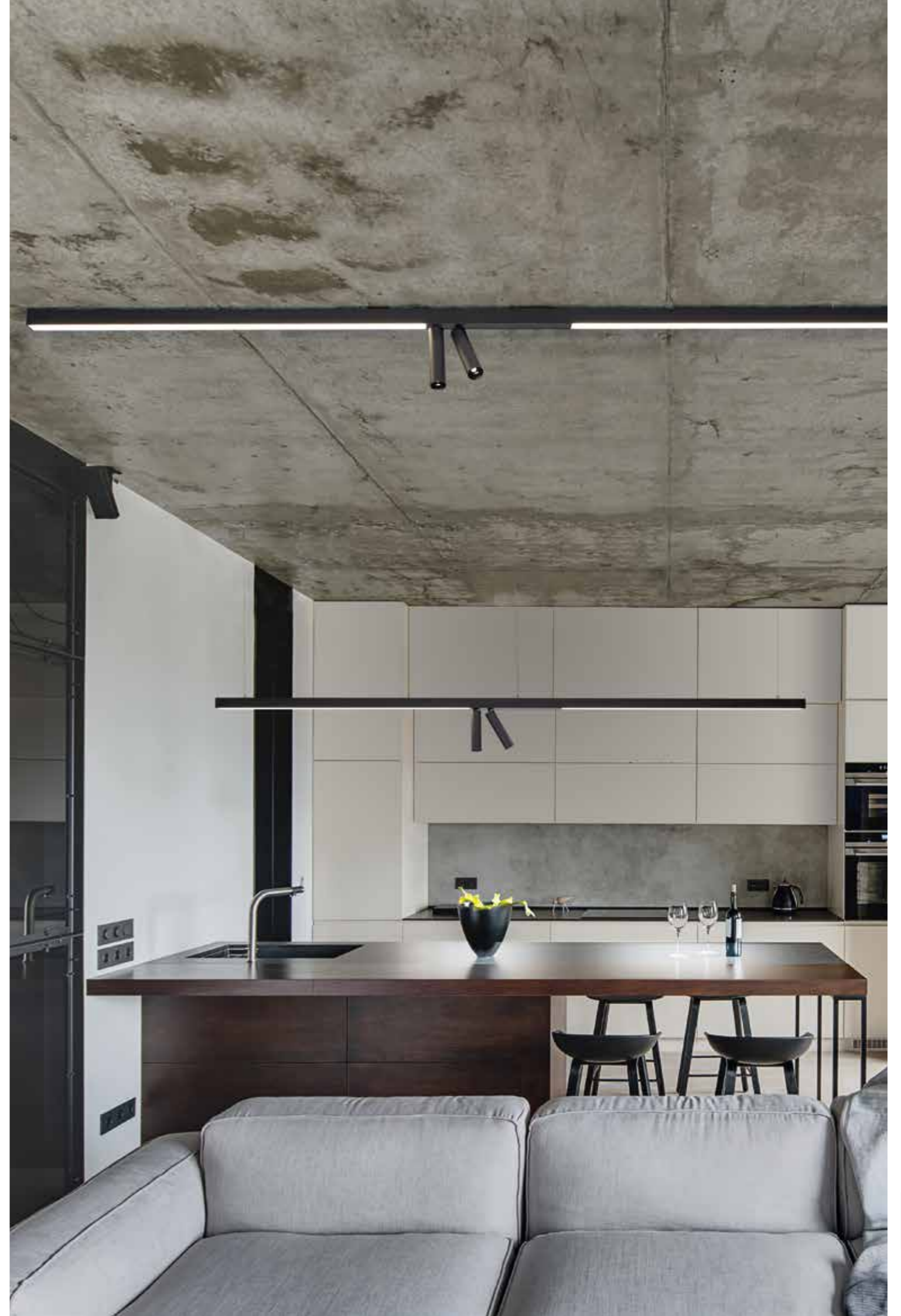

TRIGGA RIDE SYSTEM INSERT

Design: Serge & Robert Cornelissen / INHOUSE

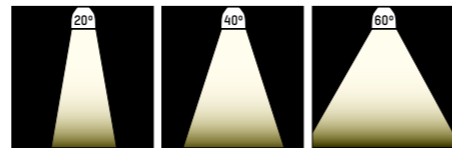

LED Strahlerleuchteinsatz aus Aludruckguss
Oberfläche in weiß, schwarz oder silber matt
Vakuumbedampfter Alurefektor in 3 Ausstrahlwinkeln
Leuchtenkopf 350° drehbar und 90° schwenkbar

LED spotlight, die cast aluminium
White, black or silver matt
Vacuum deposited aluminium reflector, 3 beam angles
Spotlight head 350° swiveling and 90° tilting

Proiettore a LED a tensione di rete
Finitura in bianco, nero o grigio opaco
Ottiche in alluminio in 3 fasci di emissione
Proiettore girevole a 350°, orientabile a 90°

Projecteur en LED à tension de red
Fini en blanc, noir ou gris mat
Réflecteur en aluminium en 3 angles d'émission
Projecteur tournant à 350°, pivotant à 90°

DALI dimm. auf Anfrage
DALI dimm. on request

A++ - A

IP 20

DASH LICHTEINSATZ / DASH LIGHT INSERT

220-240V AC - Binning SDCM 3

SYS 14W

	lm W2	lm W3	lm W4
676-0060101WWXXO	1260	1310	1400
676-0060102WWXXO	1260	1310	1400
676-0060104WWXXO	1260	1310	1400

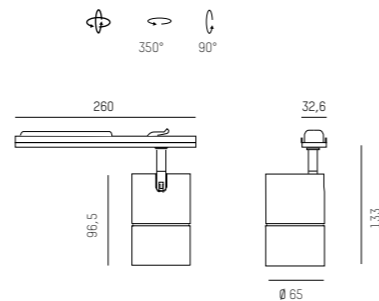

ARTIKELNUMMER ERGÄNZEN / COMPLETE CODE

WW = LICHTFARBE/LIGHT COLOUR

XX = FARBE/COLOUR

W2	LED 2700K = 43	PREMIUM CRI >90
W3	LED 3000K = 49	PREMIUM CRI >90
W4	LED 4000K = 24	CRI >90

SM	silver-matt = 04
W	white = 05
S	black = 06

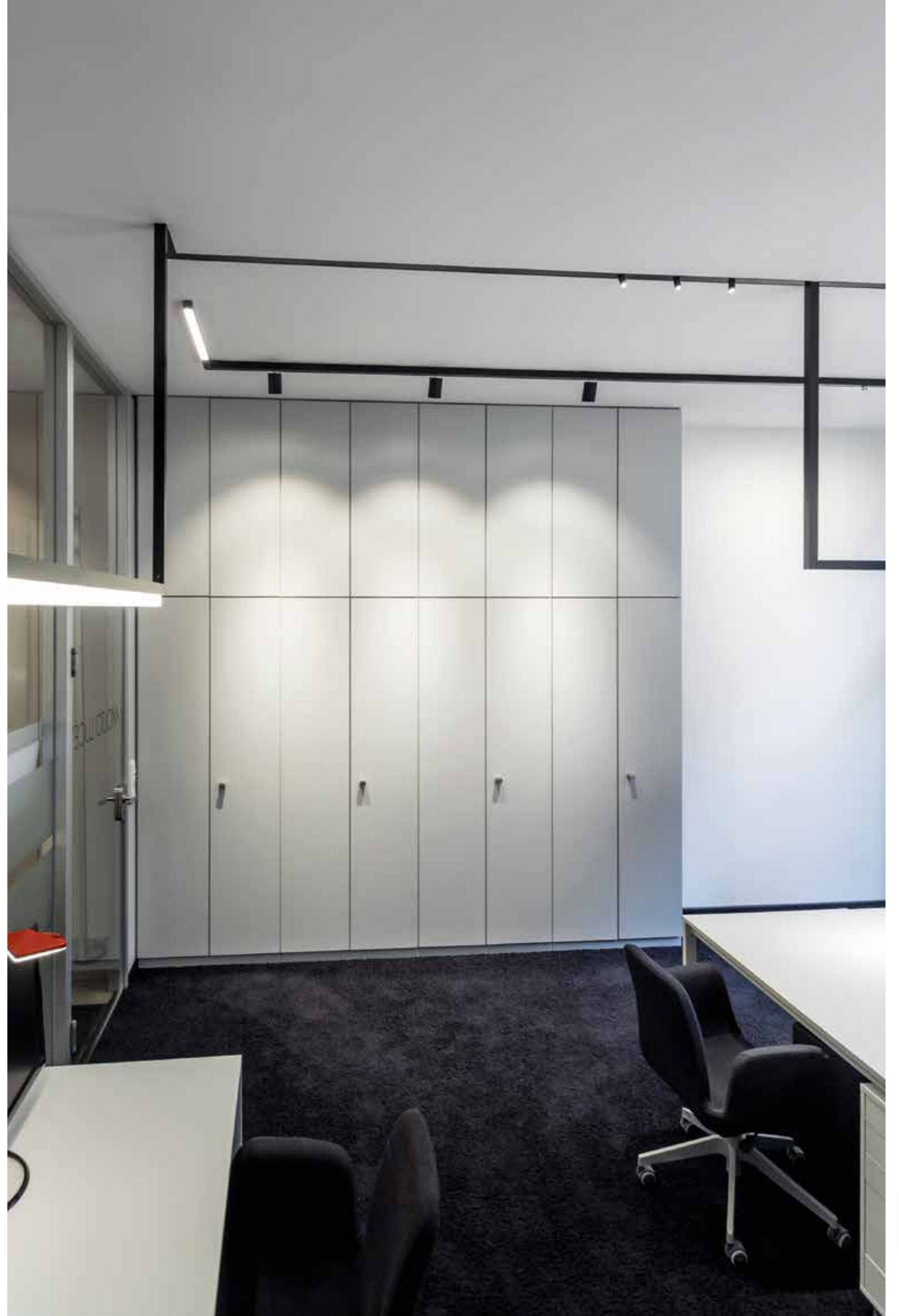

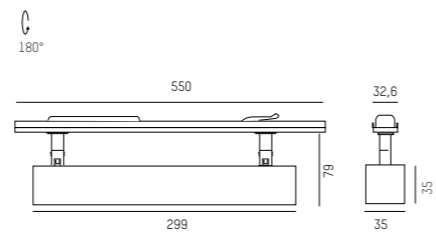
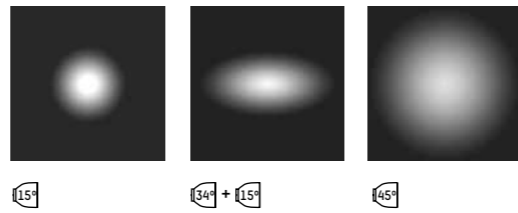

LED Strahlerlichteinsatz aus Aludruckguss
 Oberfläche in weiß, schwarz oder silber matt
 Vakuumbelagter Alurefektor in 3 Ausstrahlwinkeln
 Leuchtenkopf 350° drehbar und 180° schwenkbar

LED spotlight, die cast aluminium
 White, black or silver matt surface
 Vacuum deposited aluminium reflector, 3 beam angles
 Spotlight head 350° swiveling and 180° tilting

Proiettore a LED a tensione di rete
 Finitura in bianco, nero o grigio opaco
 Ottiche in alluminio in 3 fasci di emissione
 Proiettore girevole a 350°, orientabile a 180°

Projecteur en LED à tension de red
 Fini en blanc, noir ou gris mat
 Réflecteur en aluminium en 3 angles d'émission
 Projecteur tournant à 350°, pivotant à 180°

W2 = LED 2700K
 W3 = LED 3000K
 W4 = LED 3500K

A++ - A

IP 20 CE

RIDE LENS TURN LICHTEINSATZ / RIDE LENS TURN LIGHT INSERT

220-240V AC · CRI >90 · Binning SDCM 3

SYS 19W

634-006010123XXY	W2	15°	1400lm
634-006010129XXY	W3	15°	1530lm
634-006010124XXY	W4	15°	1400lm

634-006010623XXY	W2	34° + 15°	1330lm
634-006010629XXY	W3	34° + 15°	1450lm
634-006010624XXY	W4	34° + 15°	1330lm

634-006010323XXY	W2	45°	1400lm
634-006010329XXY	W3	45°	1530lm
634-006010324XXY	W4	45°	1400lm

ARTIKELNUMMER ERGÄNZEN / COMPLETE CODE

XX = FARBE/COLOUR

Y = DIMMBAR/DIMMABLE

W white = 05
 S black = 06
 AE aluminium anodized = 08

S switchable = 0
 D DALI dimm = d



ZURÜCK ZUR ÜBERSICHT / BACK TO OVERVIEW

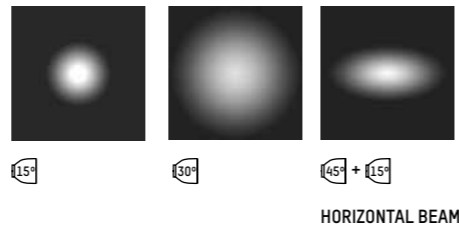

LED Systemstrahler für RIDE
 Oberfläche schwarz oder weiß pulverbeschichtet
 Zurückversetzte Linsen mit verschiedenen Abstrahlwinkeln
 Perfekte Entblendung durch Hochglanzraster
 Leuchtenkopf 355° drehbar und 90° schwenkbar

LED system spotlight for RIDE
 White or black powder coated
 Recessed lenses with different beam-angles
 Perfect anti-glare due to high-gloss grid
 355° swiveling and 90° tilting head

Faretto a LED per sistema RIDE
 Verniciatura a polveri in bianco o nero
 Lenti retrocesse con differenti fasci di emissione
 Controllo anti-abbagliato per griglia lucida
 Girevole a 355°, orientabile a 90°

Rayon à LED pour système RIDE en aluminium
 Vernissage à poudres en blanc ou noir
 Lentilles décalées au fond avec d'émissions différentes
 Contrôle anti-éblouissement pour grille brillante
 Tournant à 355°, pivotant à 90°

UGR < 19

W2 = LED 2700K
 W3 = LED 3000K
 W4 = LED 4000K

A++ - A

IP 20 CE

GRID RIDE LICHTEINSATZ / GRID RIDE LIGHT INSERT

220-240V AC · CRI >90 · Binning SDCM 3

SYS 10W

629-701213XX W2 15° 590lm
 629-701219XX W3 15° 590lm
 629-701214XX W4 15° 640lm

629-701223XX W2 30° 570lm
 629-701229XX W3 30° 570lm
 629-701224XX W4 30° 620lm

629-701233XX W2 45° + 15° 520lm
 629-701239XX W3 45° + 15° 520lm
 629-701234XX W4 45° + 15° 570lm

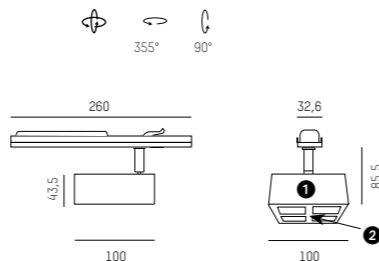

ARTIKELNUMMER ERGÄNZEN / COMPLETE CODE

X = FARBE/COLOUR

1 2
 W W white-white = 55
 S S black-black = 66
 W S white-black = 56
 S W black-white = 65

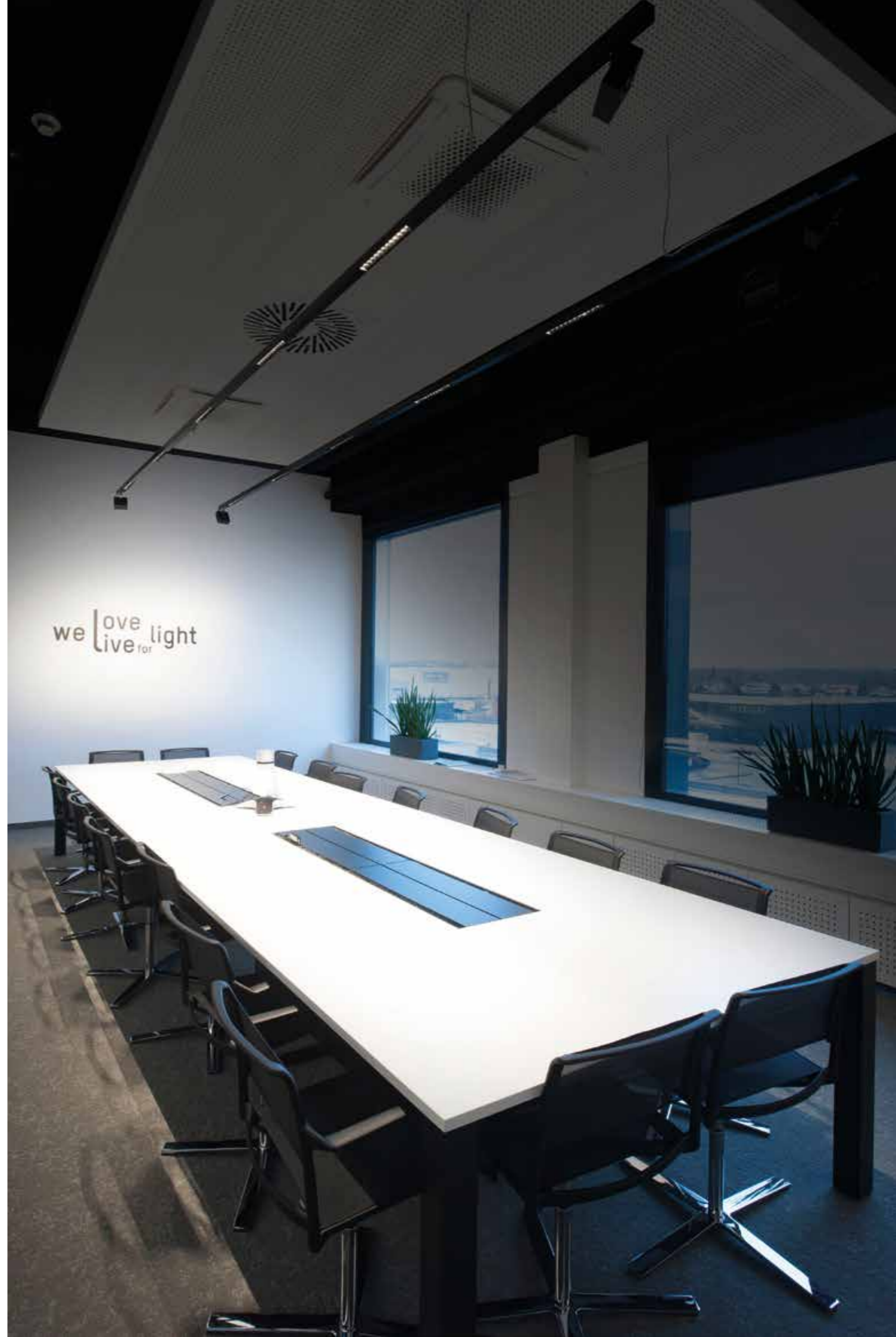

GRID RIDE SYSTEM INSERT

Design: INHOUSE



RIDE RING 750 SEGMENT

220-240V AC · CRI >90 · Binning SDCM 3 · DALI dimm.

10W / 90°

lm W2	lm W3	lm W4
820	890	930

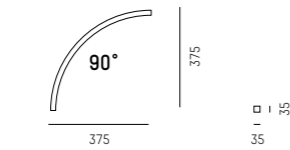

RIDE RING 750 SEGMENT

220-240V AC · CRI >90 · Binning SDCM 3 · DALI dimm.

19W / 180°

lm W2	lm W3	lm W4
1650	1790	1860

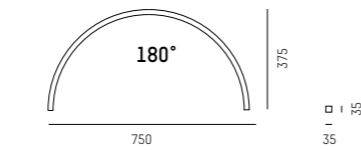

RIDE RING 1450 SEGMENT

220-240V AC · CRI >90 · Binning SDCM 3 · DALI dimm.

19W / 90°

lm W2	lm W3	lm W4
1650	1790	1860

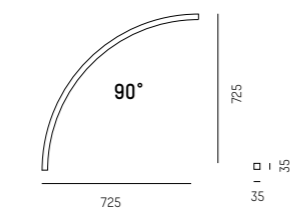

RIDE RING 1450 SEGMENT

220-240V AC · CRI >90 · Binning SDCM 3 · DALI dimm.

38W / 180°

lm W2	lm W3	lm W4
3300	3580	3720

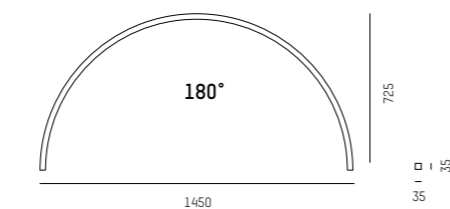

RIDE RING 850 SEGMENT LINEAR

220-240V AC · CRI >90 · Binning SDCM 3 · DALI dimm.

15W

lm W2	lm W3	lm W4
1230	1340	1400

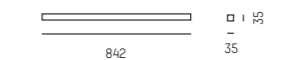

RIDE RING 1410 SEGMENT LINEAR

220-240V AC · CRI >90 · Binning SDCM 3 · DALI dimm.

24W

lm W2	lm W3	lm W4
2060	2240	2330

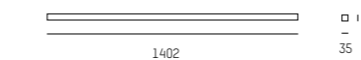

RIDE RING 2810 SEGMENT LINEAR

220-240V AC · CRI >90 · Binning SDCM 3 · DALI dimm.

48W

lm W2	lm W3	lm W4
4130	4490	4670

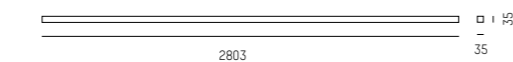

ARTIKELNUMMER ERGÄNZEN / COMPLETE CODE

W = LICHTFARBE/LIGHT COLOUR

XX = FARBE/COLOUR

W2	LED 2700K = 3
W3	LED 3000K = 9
W4	LED 4000K = 4

W	white = 05
S	black = 06
AE	aluminium anodized = 08

LED Ringsegmente aus stranggepresstem Aluminium Oberfläche eloxiert, weiß oder schwarz pulverbeschichtet Montage als Aufbau oder abgependelte Version Inkl. flache PMMA-Abdeckung

LED ring segment, extruded aluminium Anodised surface, white or black powder-coated Surface mounted or suspended version Incl. flat PMMA diffuser

Lampada in alluminio estruso a forma di segmento di anello Superficie anodizzata o verniciata a polvere in bianco o nero Montaggio a parete (plafone) od a sospensione Incl. copertura piatta in PMMA

Segment annulaire LED en aluminium extrudé Finition anodisée ou laquée blanc ou noir Montage en applique ou suspendu Incl. couvercle plat en PMMA

SYSTEMZUBEHÖR: SEITE 320/321
SYSTEM COMPONENTS: PAGE 320/321

Achtung:
Max. zulässige, durchgehende Systemlänge pro Einspeisung beträgt 15m (max. 400W)!
Die Durchgangsverdrahtung entspricht einem Querschnitt von 0,75mm²!

Attention:
System length per feed maximal 15m (max. 400W)!
The cross section of the trough wiring is 0,75mm²!

A++ - A

IP 20 CE

RIDE RING SYSTEM

Design: INHOUSE

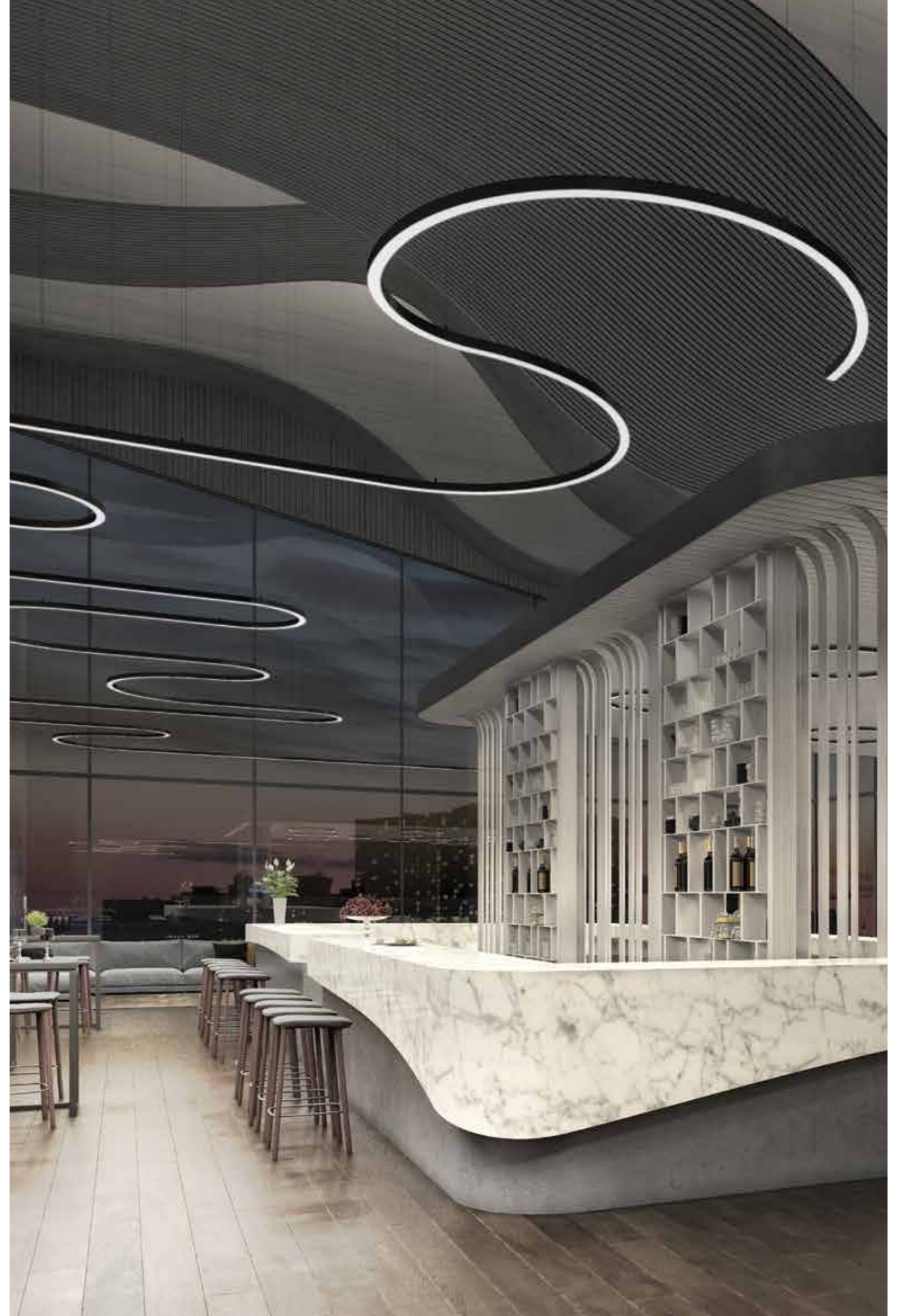

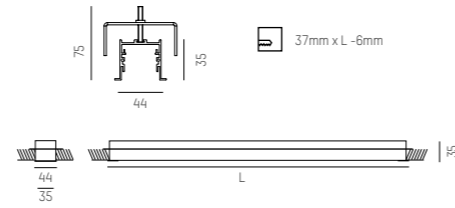

RIDE IP54 R

220-240V AC/DC · CRI >90 · Binning SDCM 3

SYS 10W (nicht dimmbar/not dimmable)

W2 = 820lm W3 = 890lm W4 = 930lm

577-014011023XX0 W2 L: 606mm
 577-014011029XX0 W3 L: 606mm
 577-014011024XX0 W4 L: 606mm

SYS 19W

W2 = 1650lm W3 = 1790lm W4 = 1860lm

577-014031023XXY W2 L: 1163mm
 577-014031029XXY W3 L: 1163mm
 577-014031024XXY W4 L: 1163mm

SYS 48W

W2 = 4130lm W3 = 4490lm W4 = 4670lm

577-014051023XXY W2 L: 2846mm
 577-014051029XXY W3 L: 2846mm
 577-014051024XXY W4 L: 2846mm

SYS 15W

W2 = 1230lm W3 = 1340lm W4 = 1400lm

577-014021023XXY W2 L: 883mm
 577-014021029XXY W3 L: 883mm
 577-014021024XXY W4 L: 883mm

SYS 24W

W2 = 2060lm W3 = 2240lm W4 = 2330lm

577-014041023XXY W2 L: 1443mm
 577-014041029XXY W3 L: 1443mm
 577-014041024XXY W4 L: 1443mm

SYS 71W

W2 = 6190lm W3 = 6730lm W4 = 7000lm

577-014061023XXY W2 L: 4246mm
 577-014061029XXY W3 L: 4246mm
 577-014061024XXY W4 L: 4246mm

LED Lichtprofil aus stranggepresstem Aluminium
 Oberfläche eloxiert oder weiß pulverbeschichtet
 Geeignet für den Einbau in Zwischendecken von 1-20mm
 Flache PMMA Abdeckung

Extruded aluminium LED profile
 Anodised or white powder coated finish
 For false ceiling 1-20mm thickness
 Flat PMMA diffuser

Profilo in alluminio pressofuso a LED
 Finitura anodizzata o verniciatura a polveri bianca
 Per cartongesso spessore 1-20mm
 Diffusore PMMA piatto

Profil en aluminium pressé de LED
 Finis anodisé ou vernissage à poudres blanc
 Pour placoplâtre de 1-20mm
 Diffuseur PMMA plat

Die Schutzart IP54 wird nur bei Deckenmontage der
 Leuchte gewährleistet
 IP54 protection applies for ceiling installation only

W2 = LED 2700K
 W3 = LED 3000K
 W4 = LED 4000K

A++ - A

IP54

ARTIKELNUMMER ERGÄNZEN / COMPLETE CODE

XX = FARBE/COLOUR

Y = DIMMBAR/DIMMABLE

W white = 05
 S black = 06
 AE aluminium anodized = 08

S switchable = 0
 D DALI dimm = d

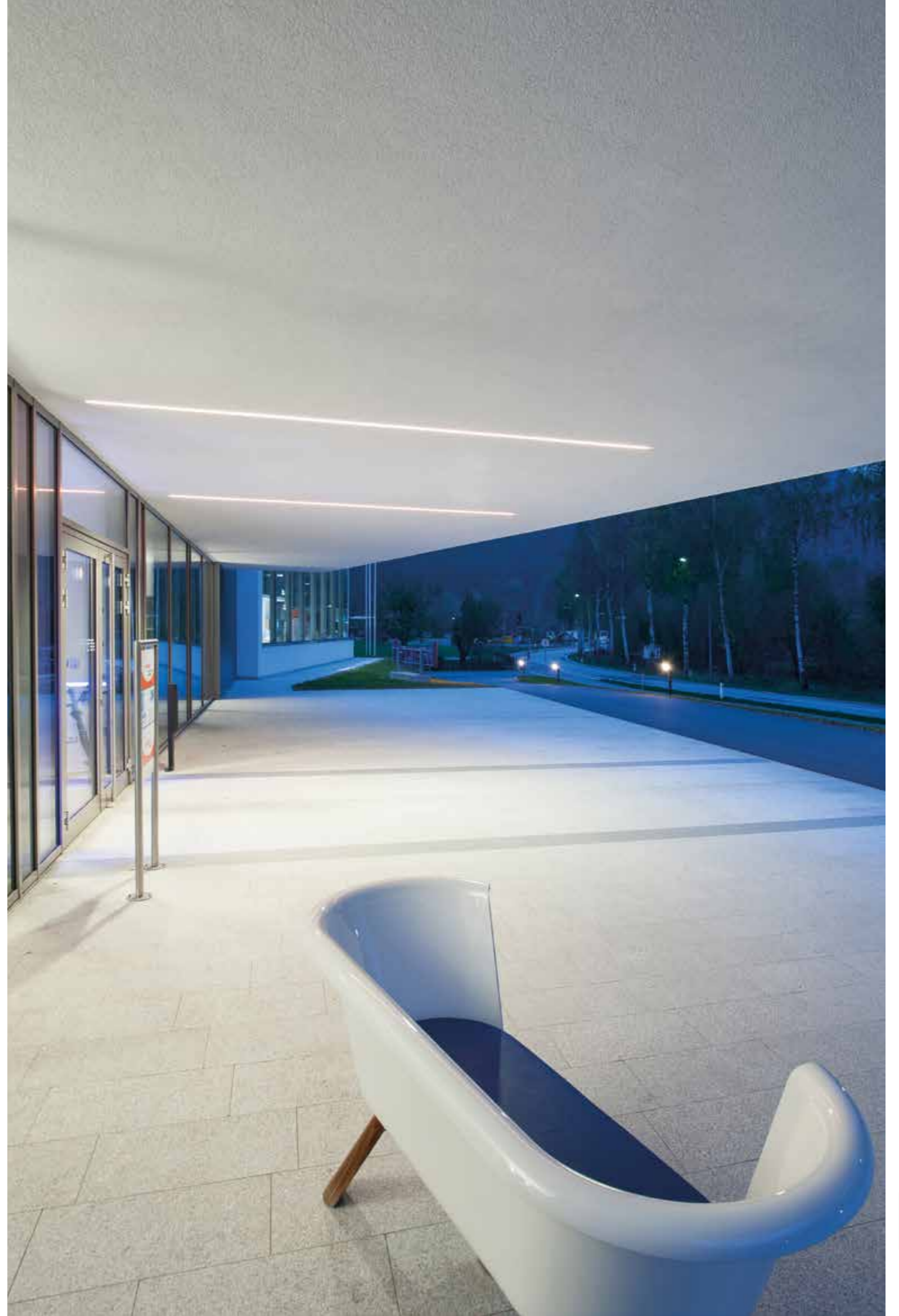

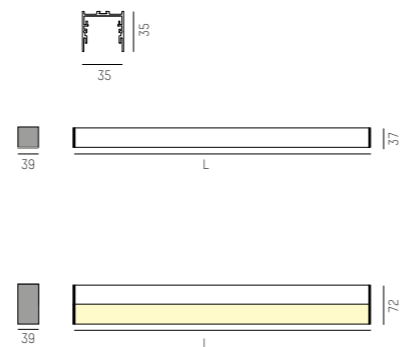

RIDE IP54 SD

220-240V AC/DC · CRI >90 · Binning SDCM 3

SYS 10W (nicht dimmbar/not dimmable)

1: $\frac{W2}{W3}$ = 820lm $\frac{W3}{W4}$ = 890lm $\frac{W4}{W5}$ = 930lm
 2: $\frac{W2}{W3}$ = 920lm $\frac{W3}{W4}$ = 1010lm $\frac{W4}{W5}$ = 1050lm

577-01301C023XXD $\frac{W2}{W3}$ L: 578mm
 577-01301C029XXD $\frac{W3}{W4}$ L: 578mm
 577-01301C024XXD $\frac{W4}{W5}$ L: 578mm

SYS 19W

1: $\frac{W2}{W3}$ = 1650lm $\frac{W3}{W4}$ = 1790lm $\frac{W4}{W5}$ = 1860lm
 2: $\frac{W2}{W3}$ = 1850lm $\frac{W3}{W4}$ = 2020lm $\frac{W4}{W5}$ = 2100lm

577-01303C023XXY $\frac{W2}{W3}$ L: 1137mm
 577-01303C029XXY $\frac{W3}{W4}$ L: 1137mm
 577-01303C024XXY $\frac{W4}{W5}$ L: 1137mm

SYS 48W

1: $\frac{W2}{W3}$ = 4130lm $\frac{W3}{W4}$ = 4490lm $\frac{W4}{W5}$ = 4670lm
 2: $\frac{W2}{W3}$ = 4640lm $\frac{W3}{W4}$ = 5050lm $\frac{W4}{W5}$ = 5250lm

577-01305C023XXY $\frac{W2}{W3}$ L: 2817mm
 577-01305C029XXY $\frac{W3}{W4}$ L: 2817mm
 577-01305C024XXY $\frac{W4}{W5}$ L: 2817mm

SYS 15W

1: $\frac{W2}{W3}$ = 1230lm $\frac{W3}{W4}$ = 1340lm $\frac{W4}{W5}$ = 1400lm
 2: $\frac{W2}{W3}$ = 1390lm $\frac{W3}{W4}$ = 1510lm $\frac{W4}{W5}$ = 1510lm

577-01302C023XXY $\frac{W2}{W3}$ L: 851mm
 577-01302C029XXY $\frac{W3}{W4}$ L: 851mm
 577-01302C024XXY $\frac{W4}{W5}$ L: 851mm

SYS 24W

1: $\frac{W2}{W3}$ = 2060lm $\frac{W3}{W4}$ = 2240lm $\frac{W4}{W5}$ = 2330lm
 2: $\frac{W2}{W3}$ = 2320lm $\frac{W3}{W4}$ = 2520lm $\frac{W4}{W5}$ = 2620lm

577-01304C023XXY $\frac{W2}{W3}$ L: 1418mm
 577-01304C029XXY $\frac{W3}{W4}$ L: 1418mm
 577-01304C024XXY $\frac{W4}{W5}$ L: 1418mm

SYS 71W

1: $\frac{W2}{W3}$ = 6190lm $\frac{W3}{W4}$ = 6730lm $\frac{W4}{W5}$ = 7000lm
 2: $\frac{W2}{W3}$ = 6970lm $\frac{W3}{W4}$ = 7570lm $\frac{W4}{W5}$ = 7870lm

577-01306C023XXY $\frac{W2}{W3}$ L: 4217mm
 577-01306C029XXY $\frac{W3}{W4}$ L: 4217mm
 577-01306C024XXY $\frac{W4}{W5}$ L: 4217mm

LED Lichtprofil aus stranggepresstem Aluminium
 Oberfläche eloxiert, weiß oder schwarz pulverbeschichtet
 Nur für Deckenmontage geeignet
 Flache oder vorspringende kubische Abdeckung

Extruded aluminium LED profile
 Anodised, white or black powder coated finish
 For ceiling mount only
 Flat or cubic diffuser

Profilo in alluminio pressofuso a LED
 Finitura anodizzata, verniciatura a polveri bianca o nero
 Solo per installazione a soffitto
 Diffusore piatto o cubico

Profil en aluminium pressé de LED
 Finis anodisé, vernissage à poudres blanc ou noir
 Seulement pour montage au plafond
 Diffuseur plat ou cubique

Die Schutzart IP54 wird nur bei Deckenmontage der Leuchte gewährleistet
 IP54 protection applies for ceiling installation only

$\frac{W2}{W3}$ = LED 2700K
 $\frac{W3}{W4}$ = LED 3000K
 $\frac{W4}{W5}$ = LED 4000K

A++ - A

IP54

ARTIKELNUMMER ERGÄNZEN / COMPLETE CODE

C = ABDECKUNG / COVER

XX = FARBE / COLOUR

Y = DIMMBAR / DIMMABLE

PMMA opal diffuser flat = 1

\frac{W} white = 05

\frac{S} switchable = 0

PMMA opal diffuser cubic = 2

\frac{S} black = 06

\frac{D} DALI dimm = d

\frac{AE} aluminium anodized = 08



